

USER GUIDE

Hybrid All-in-one ESS
Apollo-4K6LP1G01-MX
Apollo-5KLP1G01-MX



Netherlands
Mob: +48 799049508
Add: Shannonweg 39, 3197LG,
BollekRotterdam, Netherlands
Mailbox: europe@felicitysolar.com
Web: www.felicityess.com



Poland
TEL: +48 799049508
ADD :ul. Domaniewska
17/19 Lok. 133, 02-672, Warsaw, poland
MAILBOX : europe@felicitysolar.com
WEB :www.felicityess.com



Italy
Mob: +39 3519415678
Add: Via Michele Amari, 21,
47924 Rimini RN, Italia.
Mailbox :italy@felicitysolar.com
Web: www.felicityess.com



Britain
Mob: +44 07510578947
Add: No.23 Copperfield Road, Coventry,
West Midlands, England, United Kingdom
Mailbox: uk@felicitysolar.com
Web: www.felicityess.com



Ukraine
Tel: +380 93 0026635
Add: 01054, M. KniB, By. Iohuapa
Onecs, Sya, 35, o. 85, Ukraine
MailBox: Ukraine@felicitysolar.com
Web: www.felicityess.com



German
Tel: +4917673930684
Add: Münsterstr. 304, 40470 Düsseldorf, Germany
MailBox: Germany@felicitysolar.com
Web: www.felicityess.com



Important Notes

About This Manual

This manual mainly describes the product information, guidelines for installation, operation and maintenance. Due to the product development, the product specifications and functions are subject to change by time. The latest manual can be acquired via our website <https://www.felicityess.com>.

How to Use This Manual

Read the manual and other related documents before performing any operation on the product. The manual can help you when you get some problem with the product, so we suggest to keep it well.

Disclaimer

We made many attempts to make this document complete, accurate and up-to-date. Individuals reviewing this document and installers or service personnel are cautioned. However, FelicityESS reserves the rights to make changes without notice. FelicityESS should not be responsible for any damages, including indirect, incidental or consequential damages caused by reliance on the material presented including, but not limited to, omissions, typographical errors, arithmetical errors or listing errors in the material provided in this document.

The customer is fully liable for any modifications made to the system; therefore, any hardware or software modification, manipulation, or alteration not expressly approved by the manufacturer shall result in the immediate cancellation of the warranty.

FelicityESS accepts no liability for customers' failure to comply with the instructions for correct installation and will not be held responsible for upstream or downstream systems FelicityESS equipment has supplied.

Contents

Important Notes	1
Contents	2
1. Introduction	3
1.1 Overview	3
1.2 Product Features	4
1.3 Data Sheet	5
1.4 Package list	6
1.5 Installation tools	7
2. Safety and warning	7
2.1 Safety introductions	7
2.2 Symbols	8
2.3 Notice for Use	9
3. Installation	9
3.1 Install environment	9
3.2 Product Handling	11
3.3 Mounting	12
3.4 Ground Cable Installation	15
3.5 PV Cable Installation	16
3.6 Battery Cable Installation	18
3.7 Grid and Backup Wiring	21
3.8 Meter & CT Connection	23
3.9 DRMS connection (optional)	26
3.10 WIFI module installation and Monitoring	28
4. Commissioning and operation	29
4.1 Display panel and basic operation	29
4.2 LCD display	30
4.3 Setup with APP	32
5. Parallel System Wiring (Optional)	33
5.1 Introduction to Parallel Machines.....	33
5.2 Parallel installation specification	33
5.3 Single phase 230V parallel connection	34
5.4 Three phases 230V parallel connection	37
5.5 LCD Manual setting parallel Mode	39
6. Maintenance	41
7. Warning Code Table	42
8. Troubleshooting	42

1. Introduction

1.1 Overview

Thank you for choosing our all-in-one energy storage system. This manual will assist you in becoming familiar with this product. Please keep this manual available at any time. And read the manual and other related documents before performing any operation and take into account the connection requirements by your local grid utility. This manual cannot include complete information about the photovoltaic (PV) system. All descriptions in the manual are for guidance only.

This manual describes the installation process, maintenance, technical data and safety instructions for the following models:

Apollo-4K6LP1G01-MX/ Apollo-5KLP1G01-MX

Apollo:Hybrid all in one ESS series

4K6/5K:Rated power is 4600W/5000W

L:Low voltage

P1:Single phase

G01:Generation 01

MX:The number of battery module. M4 means 4 battery modules. It can be 2-5 in this model

This manual is intended for qualified persons and inverter owners. All activities described in the document may only be carried out by specially trained personnel in compliance with standards, wiring rules and the requirements of local grid authorities or companies. Moreover, they must also understand basic safety precautions and with the knowledge of how to deal with the dangers and risks associated with installing, repairing and using electrical devices and batteries.

Before all the steps, we would like to remove the protect plate of the inverter on both left and right side. Then we will see many ports.

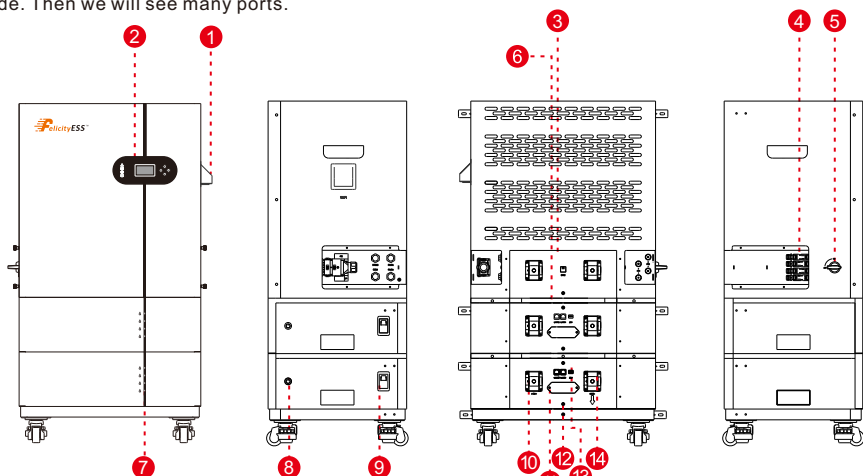

* 11. Fuse(Non professionals are not allowed to open this cover)

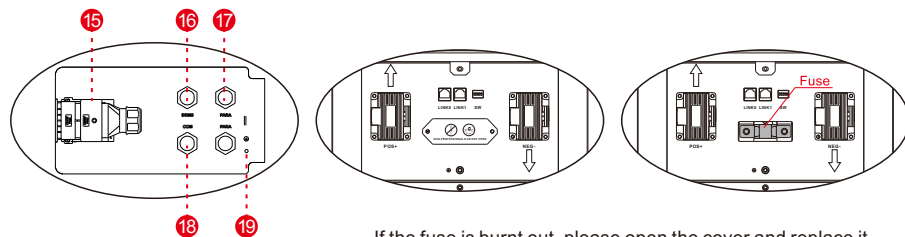

If the fuse is burnt out, please open the cover and replace it

Inverter Wire Box and Connection Points

Number	NAME	DESCRIPTION
1	WIFI module	For installing the WIFI module
2	LCD display	Display the status and basic operation
3	BMS port	Conduit for Battery communication (Inverter site)
4	PV port	Conduit for PV conductors should be connected here
5	PV Switch	Switch on and switch off the PV connection to inverter
6	Battery communication	Conduit for Battery communication (Battery site)
7	Battery LED	Showing battery SOC
8	Batter Power	Click to power on the battery
9	Battery Breaker	Pull to connect or disconnect battery with inverter
10	Battery Power Port Positive site (+)	Conduit for Battery power connection
11	Battery Fuse	Easy window to replace the fuse. Non-professionals are not allowed to open this cover
12	Battery grounding port	Grounding, connect to the ground cable
13	Battery switch	Conduit for setting the communication address
14	Battery Power Port Negative site (-)	Conduit for Battery power connection
15	AC Terminal	Conduit for AC,backup loads and smart meter should be connected here
16	DRMS port	Ready for DRMS controller connection
17	PARA port	Conduit for system parallel
18	COM port	Conduit for smart meter communication
19	Inverter Grounding port	Grounding, connect to the ground cable

1.2 Product Features

- Compact design saves your space and installation cost.
- Flexible inverter power from 4.6kw ~ 30kw (maximum 6 systems in parallel).
- Flexible Storage Capacity with modular batteries from 5kwh ~ 20kwh. (maximum 6 systems in parallel will expand to 120kwh)
- Safer and longer working life with modular LFP battery.
- Complete protection against Over Voltage, Over Temperature, and Overload.
- Programmable supply priority for battery or grid.
- Auto restart while AC is recovering.
- Hybrid inverter maximize solar power and minimize grid energy usage.
- 100% output in off-grid mode.
- With power limit function, prevent excess power overflow to the grid.
- All in one design save the installation time and space.
- Using hybrid inverters and modular batteries.
- Smart settable three stages MPPT charging for optimized battery performance.
- Real-time Remote Control via APP and website.
- Peak balancing, Time setting and other grid services.

1.3 Data Sheet











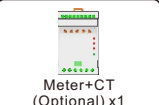

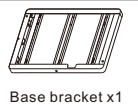

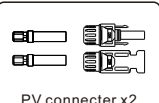
Apollo-5KLP1G01-MX Series Data sheet				
Model	Apollo-4K6LP1G01-M1	Apollo-4K6LP1G01-M2	Apollo-5KLP1G01-M1	Apollo-5KLP1G01-M2
System Specification				
Nominal Output Power	4600VA/4600W		5000VA/5000W	
AC Output Frequency and Voltage	50/60Hz; L/N/PE 220/230Va.c			
Grid Type	Single Phase			
Energy Range (kWh)	5.12	10.24	5.12	10.24
Max. Charging/Discharging Current (A)	100			
Battery Operating Voltage (V)	44.8-57.6			
Battery Type	LiFePO4			
IP Rating of Enclosure	IP21			
System Certification	VDE-AR-N 4105; G99/1; EN50549-1; CEI 0-21; AS 4777.2			
Warranty[1]	5 Years(For the Inverter);10 Years(For the battery)			
Inverter Technical Specification				
Max. PV Input Power(W)	6000		6500	
Max. PV Input Current(A)	15/15			
Rated PV Input Voltage (Vdc)	90~550			
Start Up DC Voltage (Vdc)	130			
MPPT Voltage Range(Vdc)	100~500			
Max. PV Short-circuit Current (A)	18/18			
No. of MPP Tracker	2/1			
Peak Power (off grid)	2 time of rated power, 0.2s			
Power Factor	0.8leading to 0.8lagging			
DC injection current (mA)	THD<3% (Linear load<2%)			
Display	LCD+LED			
Operating Temperature Range (°C)	-20°C~55°C,>45°C Derating			
Relative Humidity	15% ~ 85% (No Condensing)			
Dimension(Wx Dx H,mm)	600x450x640			
Weight Appr.(kg)	60			
Communication with BMS	CAN/RS485			
Grid Regulation	VDE-AR-N 4105; G99/1; CE: EN50549-1, NRS 097-2-1; CEI 0-21; AS 4777.2			
Safety Regulation	IEC 62109-1/2, IEC 62040-1			
EMC	EN61000-6-1, EN61000-6-3			
Max. efficiency	97.6%			
Euro efficiency	97.0%			

MPPT efficiency	99.9%			
Battery Technical Specification				
Nominal Voltage (V)	51.2			
Battery Module Energy (kWh)	5.12	10.24	5.12	10.24
Scalability	Max.8pcs,Max.capacity of 40.96kWh			
Battery Module Dimension (WxDxHmm)	600*450*180	600*450*360	600*450*180	600*450*360
Battery Base Dimension (WxDxHmm)	590*440*120			
Battery Module Weight Appr.(kg)	46	92	46	92
Charging Temperature Range	0°C~55°C			
Discharging Temperature Range	-20°C~55°C			
Cycle Life	≥6,000 Cycles(Test conditions: 0.2C Charging/ Discharging @25°C, 80% DOD.)			
Battery Module Certification	UN38.3.CE			
AC Output Voltage	230Va.c			
AC Output Frequency	50/60Hz			
AC Output Rated Current	20Aa.c		21.7Aa.c	
Max. AC Output Current	40Aa.c			
AC Output Rated Active Power	4600W*		5000W*	
AC Output Rated Apparent Power	4600VA*		5000VA*	
AC Output Power Factor	0.8 Leading To 0.8 Lagging			
[1]Conditions apply, refer to FelicityESS Warranty policy				

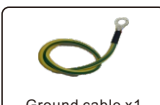
1.4 Package list

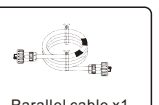
Check the equipment before installation. Please make sure nothing is damaged in the package. You should have received the items in the following package. If anything is missing, please contact your local FelicityESS distributor.

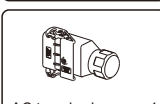
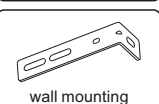
Apollo-5KLP1G01-MX

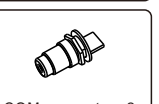
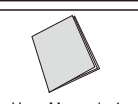
 Inverter x1	 Meter+CT (Optional) x1	 Universal wrench x1	 Wheel x4	 Base bracket x1
 WiFi plug x1	 PV connector x2	 M5 combinations crew x12	 M6 combinations crew x16	 Hexagon combinations crew x52
 Ground cable x1	 Plastic expansion nail x4	 Parallel connector x1	 Parallel cable x1	 AC connector x1
 AC terminal cover x1	 wall mounting bracket x4	 Communication line x1	 COM connector x2	 User Manual x1

LUX-X-48100LMG01

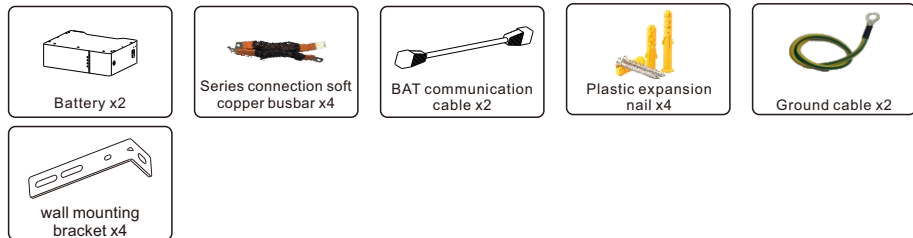

1.5 Installation tools

Check the equipment before installation. Please make sure nothing is damaged in the package. You should have received the items in the following package. If anything is missing, please contact your local Solis distributor.



2. Safety and warning

2.1 Safety introductions

- This chapter contains important safety and operating instructions. Please read and keep this manual for future reference.
- Before using the inverter, please read the instructions and warning signs of the battery and corresponding sections in the instruction manual.
- Do not disassemble the inverter. If you need maintenance or repair, take it to a professional service center.
- Improper reassembly may result in electric shock or fire.
- To reduce risk of electric shock, disconnect all wires before attempting any maintenance or cleaning. Turning off the unit will not reduce this risk.
- Caution: Only qualified personnel can install this device with battery.
- Never charge a frozen battery.

- For optimum operation of this inverter, please follow required specification to select appropriate cable size. It is very important to correctly operate this inverter. Be very cautious when working with metal tools on or around batteries. Dropping a tool may cause a spark or short circuit in batteries or other electrical parts, even cause an explosion.
- Please strictly follow installation procedure when you want to disconnect AC or DC terminals.
- Please refer to "Installation" section of this manual for the details.
- Grounding instructions - this inverter should be connected to a permanent grounded wiring system. Be sure to comply with local requirements and regulation to install this inverter.
- Never cause AC output and DC input short circuited. Do not connect to the mains when DC input short circuits.

2.2 Symbols

The following types of safety instructions and general information will appear in this document as described below:

Symbols	Name	Instruction
	Danger	Serious physical injury or even death may occur if not follow the relative requirements
	Warning	Physical injury or damage to the devices may occur if not follow the relative requirements
	Electrostatic sensitive	Damage may occur if not follow the relative requirements
	Hot surface	Sides of the device may become hot. Do not touch.
	Earth terminal	The inverter must be reliably grounded.
	Caution	Ensure that DC and AC side circuit breakers have been disconnected and wait at least 5 minutes before wiring and checking.
NOTE	Note	The procedures taken for ensuring proper operation.
CE	CE mark	The inverter complies with the CE directive.
	EU WEEE mark	Product should not be disposed as household waste.

2.3 Notice for Use

The ESS system has been constructed according to the applicable safety and technical guidelines, use the ESS system in installations that meet the following specifications only:

- Permanent installation is required.
- The electrical installation must be compliant with all local and national regulations & standards.
- The ESS must be installed according to the instructions stated in this manual section 3.4.
- The ESS must be installed according to technical specifications.

2.4 Notice for Disposal

- This product shall not be disposed of with household waste.
- It must be segregated and brought to an appropriate disposal facility to ensure proper recycling.
- This is to be done in order to avoid negative impacts on the environment and human health.
- Local waste management rules shall be observed and respected.

3. Installation

3.1 Install environment

When selecting a location for the product, the following criteria should be considered:

1. Sun and Temperature: Exposure to direct sunlight may cause output power derating due to overheating. It is recommended to avoid installing the machine in direct sunlight. The working temperature is $-25^{\circ}\text{C} \sim 60^{\circ}\text{C}$, but the ideal temperature should be $15 \sim 25^{\circ}\text{C}$.
2. Humidity: High humidity environment can lead to a decrease in the insulation performance of electronic components, causing malfunction of electrical equipment. In addition, high humidity can also lead to rusting of metal parts, affecting the life of the equipment. So, we suggest to choose a dry place for installation. At least, it should be non-condensing.

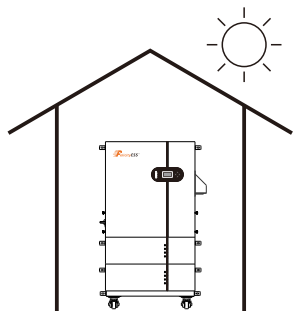

3. Air: Do not install in small, closed rooms where air cannot freely circulate. Well-ventilated environment also helps to keep a good temperature.
4. Loading: Max load bearing capacity of the wall should higher than 4 times of machine weight.
5. Clearance and space: Ensure there is sufficient space for heat-releasing. Generally, it requires 300mm for each site.

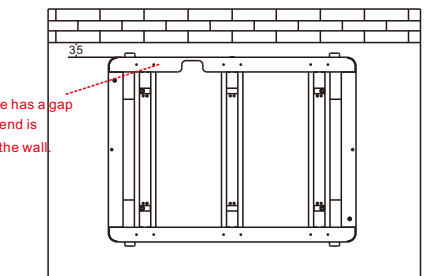
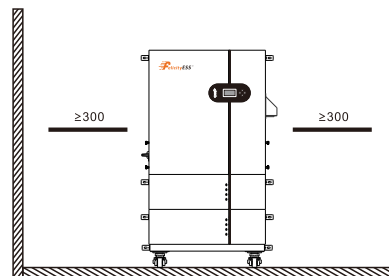

6. Surrounding: Please ensure that there are no flammable or explosive materials located near the system, and make the area clean and accessible for installation.
7. Protect from bad weather: The installation of ESS should be protected under shelter from direct sunlight, snow laying, rain exposure, lightning and etc.

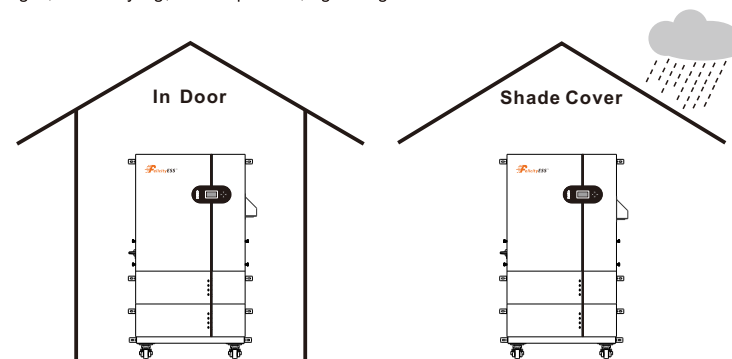

8. Avoid living area: Do not install in a living area where the prolonged presence of people or animals is expected. Depending on where the system is installed (for example: the type of surface around the machine, the general properties of the room, etc.) and the quality of the electricity supply, the sound level from the inverter can be quite high.



WARNING: Risk of fire

- Despite careful construction, electrical devices can cause fires.
- Do not install the inverter in areas containing highly flammable materials or gases.
 - Do not install the inverter in potentially explosive atmospheres.
 - The mounting structure where the inverter is installed must be fireproof.



CAUTION: Hot Surface

- The temperature of the inverter heat-sink can reach 75C

Note: Install it at eye level in order to read the LCD display easier.

Overview wiring system

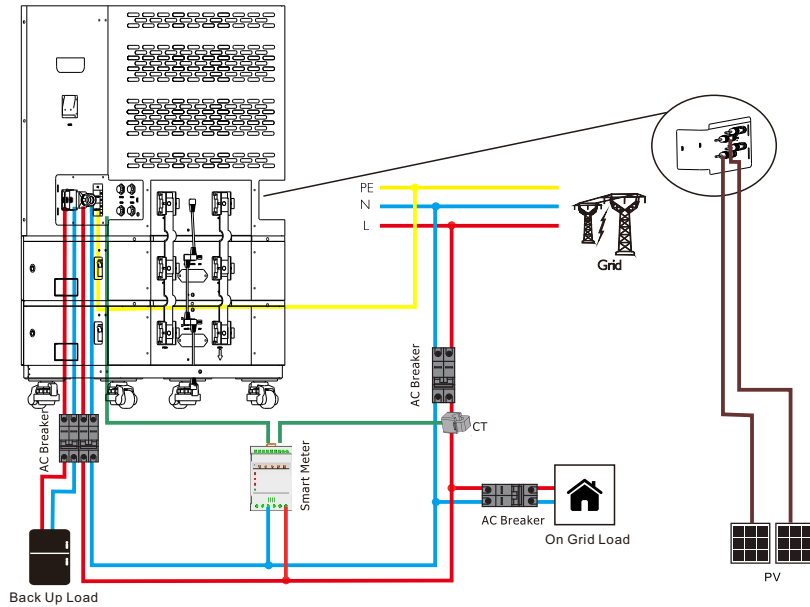

3.2 Product Handling

Please review the instruction below for handling the inverter:

1. The red circles below denote cutouts on the product. Push in the cutouts to form handles for moving the inverter and battery.

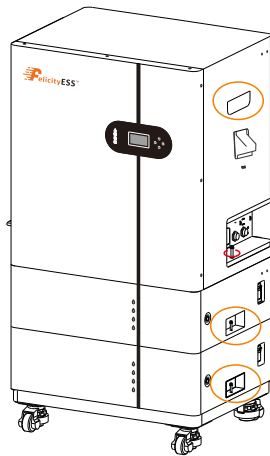

2. Two people are required to remove the inverter from the shipping box. Use the handles integrated into the heat sink to remove the inverter from the carton.



The machine is heavy please be careful when moving

3. When setting the machine down, do it slowly and gently. This ensures that the internal components and the outer chassis from damage.

3.3 Mounting

Location selecting already talked in [Install environment]. Please mount the unit tightly on a solid or smooth surface. Open the packages and middle cover kit, then take out the subjects. The size is as follow.

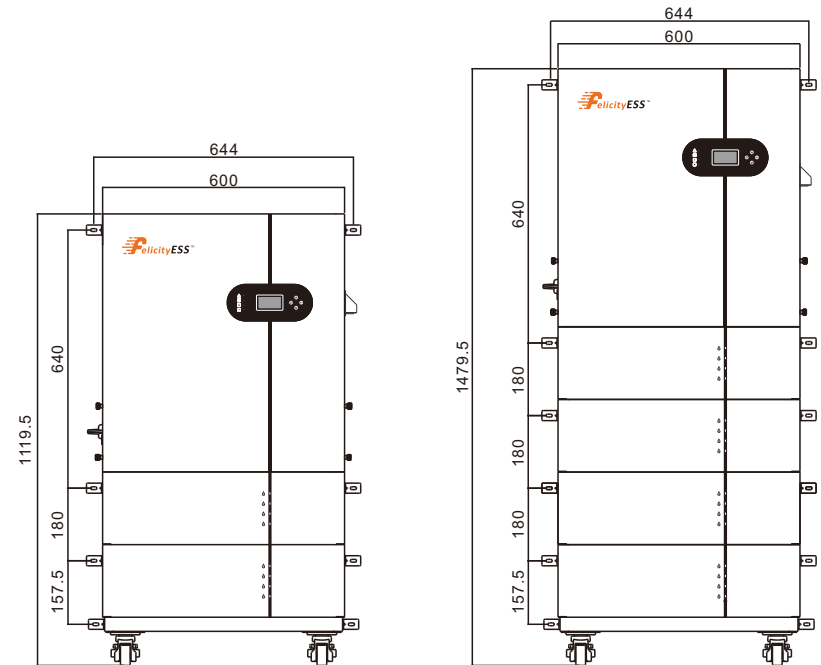

STEP 1: Remove the cover

Remove the waterproof cover from both sides of the inverter and set it aside.

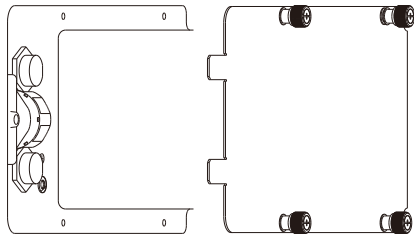

STEP 2: Install the wheels for the base bracket

Fix the 4 casters on the base bracket with M6×16 screws as the picture shows.

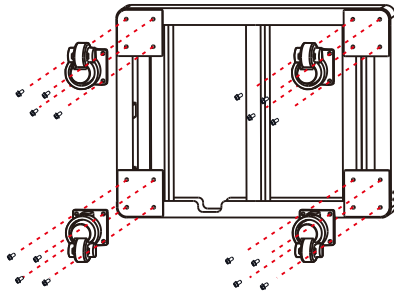

Step 3: Mark and drill holes

Use wall mounted positioning cardboard to mark the holes layer by layer. Drill holes according to the position marked on the wall. (the hole diameter is 10mm, drilling depth is 60mm)

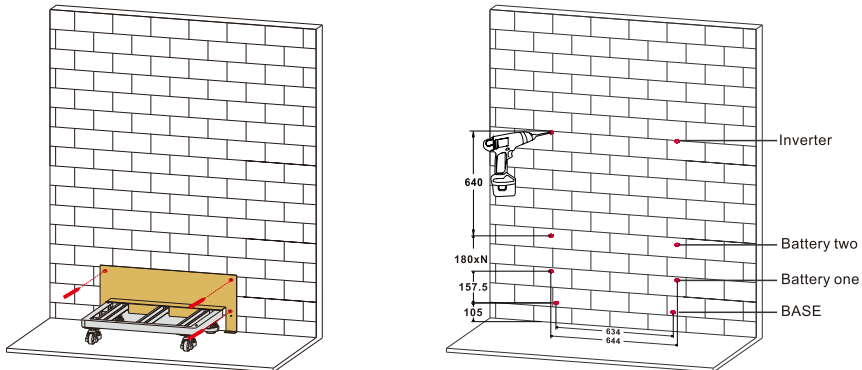

Step4: Assemble Mounting Bracket and stack together

Assemble the wall mounting bracket with screws on the inverter and batteries as shown below. Then stack and place the products, with a base on the bottom layer, batteries on the middle layer, and inverter on the top layer

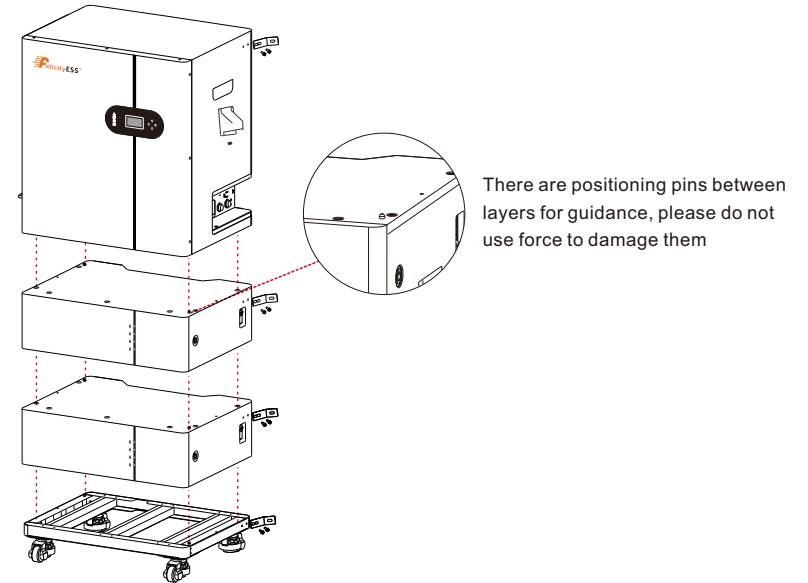

There are positioning pins between layers for guidance, please do not use force to damage them

Step5: Tighten the connection between layers with hexagonal screws for both sides.

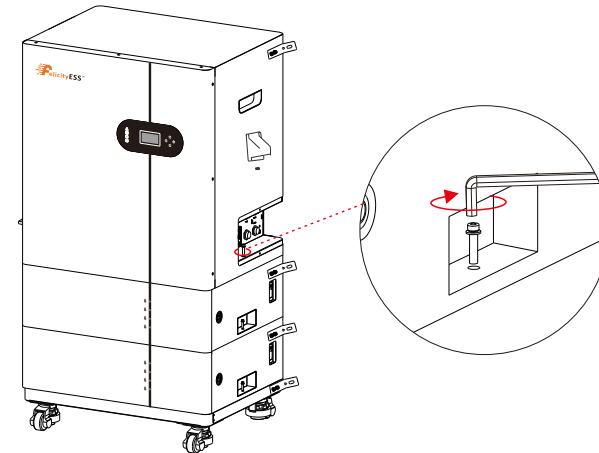

Step6 : After all the wiring finish, fix the system on the wall with screws and expand nails. Fix the cover back to the ports for protection.

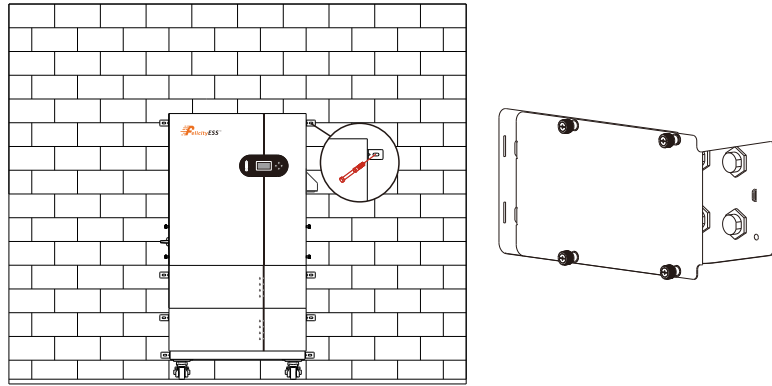

3.4 Ground Cable Installation

An external ground cable shall be connected to ground plate on right side first, before connecting other cables. This helps prevent electric shocking and improving electromagnetic interference resistance. For system with single inverter, it is only necessary to connect the ground cable. For a multi-inverter system, all ground cables of the inverter need to be connected to the ground copper bar to ensure equipotential connection.

Step 1. Prepare OT terminals: M5. Use wire strippers to crimp the lug to the terminal with a suitable length. Then thread the wire into the terminal and press it with a crimper.

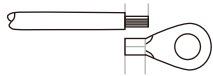

Step 2. Connect the OT terminal with ground cable to the right side of inverter with screw. The torque is 2N.m.

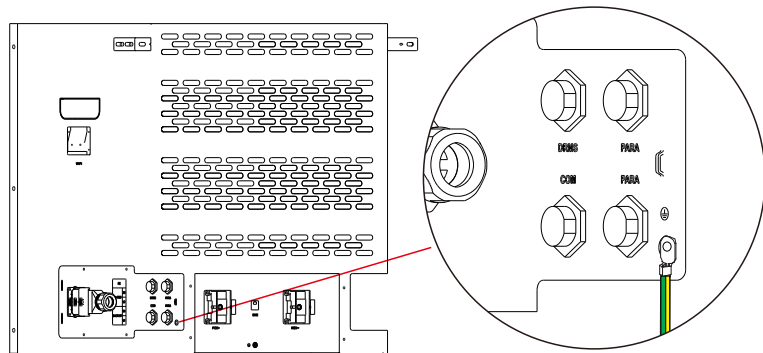

3.5 PV Cable Installation

- 1) For safety, please install a separately DC breaker between inverter and PV strings.
- 2) Block the PV with an opaque material and turn off the DC breaker.
- 3) The total short-circuit current of PV string must not exceed inverter's max DC current.
- 4) The minimum isolation resistance to ground of the PV string must exceed 19.33kΩ in case to prevent shock hazard.
- 5) PV string could not connect to earth/grounding conductor.
- 6) Use the right PV plugs in the accessory box.
- 7) Make sure polarity is correct. The inverter will not function properly if any PV polarity is reversed.

Step 1 Assembling the PV Connectors

• Select a suitable DC cable and strip the wires out by 6-8mm. Please refer to the table below for specific specifications.

Cable type	Wire Size	Cross-Section	Strip Cable length
Industry generic PV cable	12 AWG	4~6mm ²	6-8mm

- Assemble the cable ends with the crimping pliers.
- Lead the cable through the cable gland and insert the crimp contact into the insulator until it snaps into place and a "click" sound is heard. Gently pull the cable backward to ensure firm connection.
- Tighten the cable gland and the insulator.

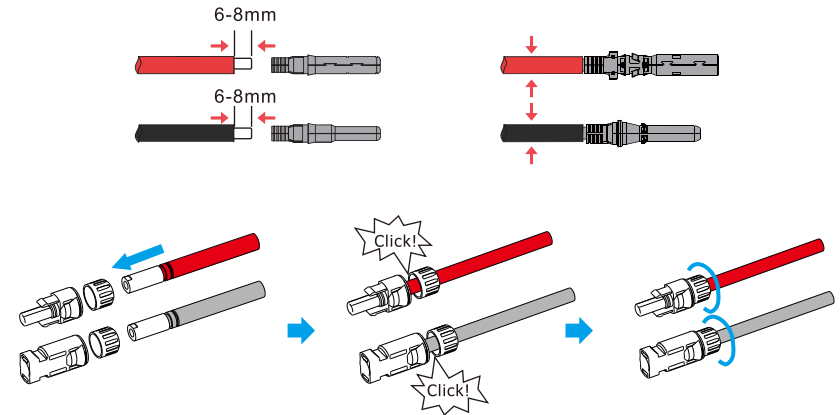

Step 2. Verify polarity

Measure PV voltage of DC input with multimeter, verify DC input cable polarity.



Step 3: Connecting the PV cables to the inverter

- Connect the PV connectors to the corresponding terminals until a “click” sound is heard.
- Seal the unused PV terminals with the terminal caps.

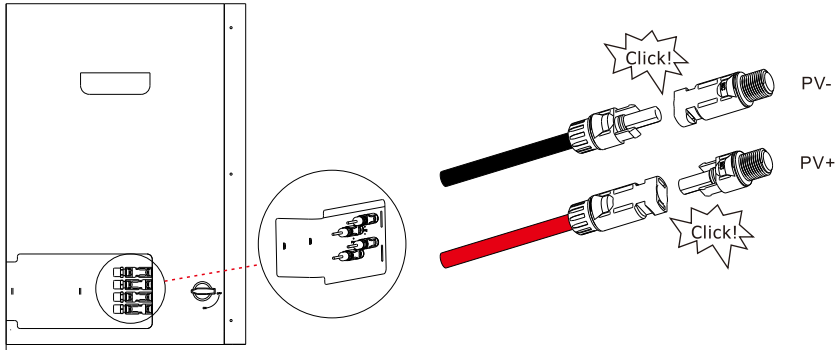

3.6 Battery Cable Installation



•The polarity of battery cannot be connected reversely, otherwise the inverter could be damaged.



DANGER

Before installing the battery cables, be sure that the battery is turned off. Use a multimeter to verify that the battery voltage is 0Vdc before proceeding. Consult the battery product manual for instructions on how to turn it off.



NOTE

Before connecting the battery, please carefully read the product manual of the battery and perform the installation exactly as the battery manufacturer specifies in the manual

Take the prepared battery copper bar and BMS communication cable from package. In section mounting, we already stacked the inverter and battery together.

Step 1. Connect the grounding wire for the battery

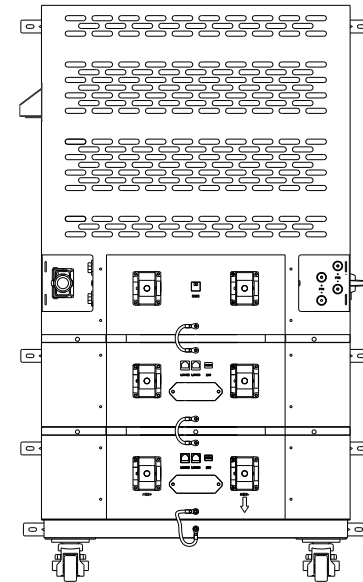

Step 2. Please open the lid latch upwards, rotate the lid and tear off the lid cover. Use screws to connect the copper bar with the ports in same pole. Positive pole connected from bottom to top and the negative pole connected from top to bottom. (The direction already printed on the battery)

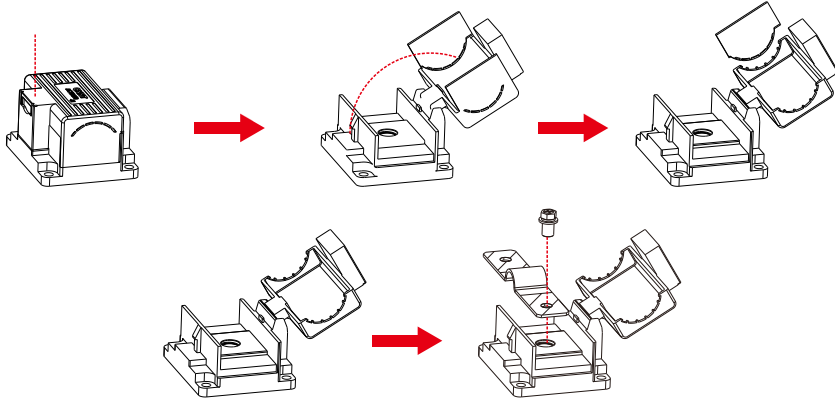

Step 3. Connect [BMS] to [LINK1],[LINK 0] to [LINK 0] with battery communication cables.

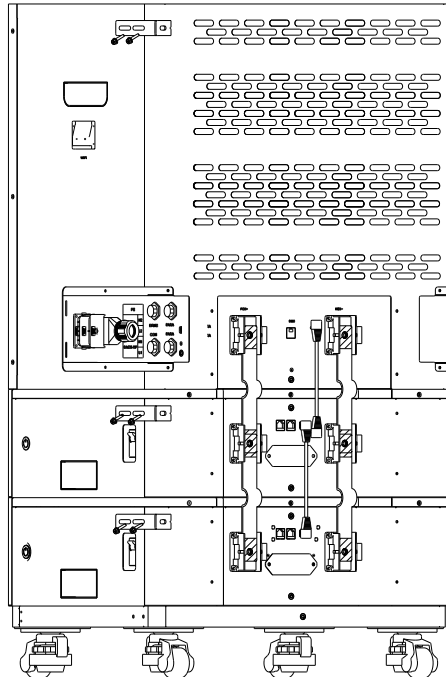

Step 4. Adjust each battery pack dialer from left to right according to the diagram below (from top to bottom).

1	2	3	4
ADS	ADS	ADS	ADS

DIP SWITCH		
	1-4	Communication Address
	5	Termination Resister

After installation, it will look like the picture shown below. This ESS support maximum 4 battery in parallel. If you need more battery bank work in parallel, connect the battery in same way.

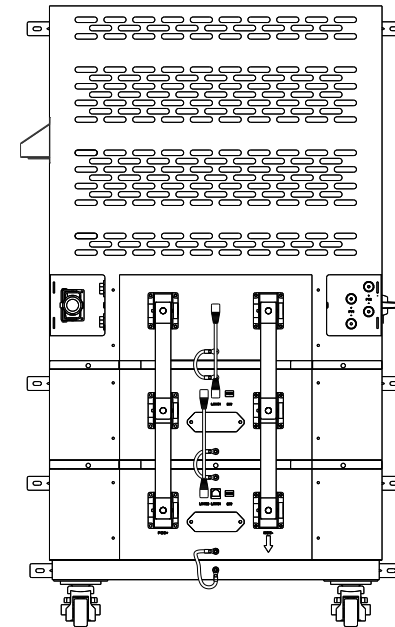

Notes:

- The battery (+) and (-) cables shall only be connected to the inverter BAT terminals.
 - For safe operation and compliance, a two-pole DC circuit breaker with overcurrent protection should be installed between the inverter and the battery.
 - Please be careful of any electric shock or chemical hazards. For batteries without a built-in DC breaker, make sure that an external DC breaker (≥125A) connected.
- The BMS Pin definition are as follow. If you need to make another one, please make sure the right wire sequence, otherwise will cause failure.

Table :Detailed Pin Function Of COM Port On All-in-one

Position	Function	Note	
1	485_A2	RS485-2 For Meter	
2	485_B2		
3	485_A3	RS485-3 For Remote Monitor	
4	485_B3		
5	485_B3		
6	485_A3	Dry Signal	
7	RY_4		
8	RY_5		

Picture	PIN	Description
	1	Trigger-GND
	2	Trigger-VCC
	3	CANL-PCS
	4	CANH-PCS
	5	RS485-B
	6	RS485-A
	7	CANL
	8	CANH

Pin function of LUX-X-48100LMG01 battery

The LED shows the SOC of each battery.

100%	75%	50%	25%	Flashing SOC < 10%

3.7 Grid and Backup Wiring

Before connecting to grid, please install a separate AC breaker between inverter and grid. The absence of AC breaker on back-up side will lead to inverter damage if an electrical short circuit happens on back-up side. The requirements of on-grid AC breaker are shown as below.

INVERTER MODEL	AC BREAKER SPECIFICATION
Apollo-5KLP1G01-MX	40A/230V,2P

There are two terminal blocks with "Grid" and "Load " markings. Please do not misconnect input and output connectors.

	Description
Backup load connectionn	10AWG, Cross section 4 mm2
Grid connection wire	10AWG, Cross section 6 mm2
Strip length	10mm

Please follow below steps to implement Grid and Back up Load port connection:

STEP 1. Before making Grid, load port connection, be sure to turn off AC breaker or disconnector first.

STEP 2. Strip the wires by 10mm length, unscrew the bolts, cross the wires through the water prof cap.

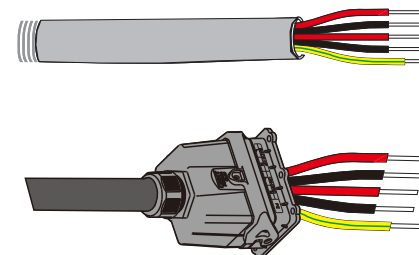

STEP 3. Insert the wires according to the correct polarities indicated on the terminal block.

(L1N1 for backup load,L2N2 for grid)Then lock the cable by press the bar until hear the click sound. Make sure the connection is complete.

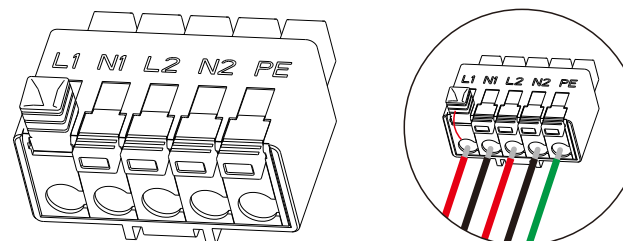

STEP 4. Insert the wire terminal inside the AC cover until here click sound. then tighten the nut

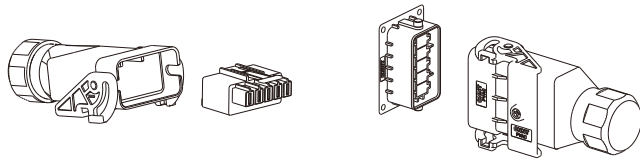

STEP 5. Connect the combined AC cables with inverter with AC PORT. Then tighten the screw in the AC terminal

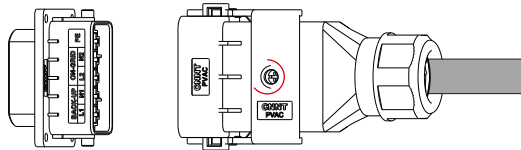

3.8 Meter & CT Connection

The Smart Meter with CT in product box is compulsory for this ESS installation, which used to detect grid voltage and current direction and magnitude.

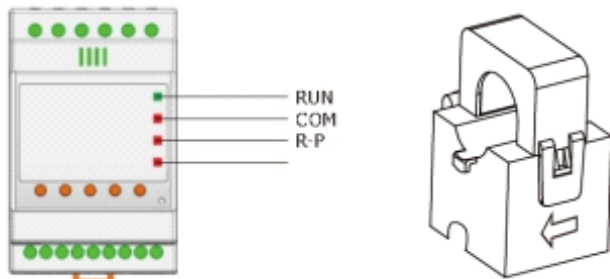

The Smart Meter with CT in product box is compulsory for this ESS installation, which used to detect grid voltage and current direction and magnitude.



CAUTION:

Make sure the AC cable is totally isolated from AC power before connecting the smart meter or CT.

Note:

- Make sure AC cable is totally isolated from AC power before connecting Smart Meter.
- One Smart Meter can only be used for one hybrid inverter.
- Normally the smart meter should be placed in or near the grid distribution box right after the billing meter.
- Please use the smart meter communication cable in the package.

Please strip the wires and install the meter as the figure. It is recommended to use 0.5A or 3A for the fuse in the connection diagram.

Please strip the wires and install the meter as the figure(1 to L, 4 to N).It is recommended to use 0.5A or 3A for the fuse in the connection diagram

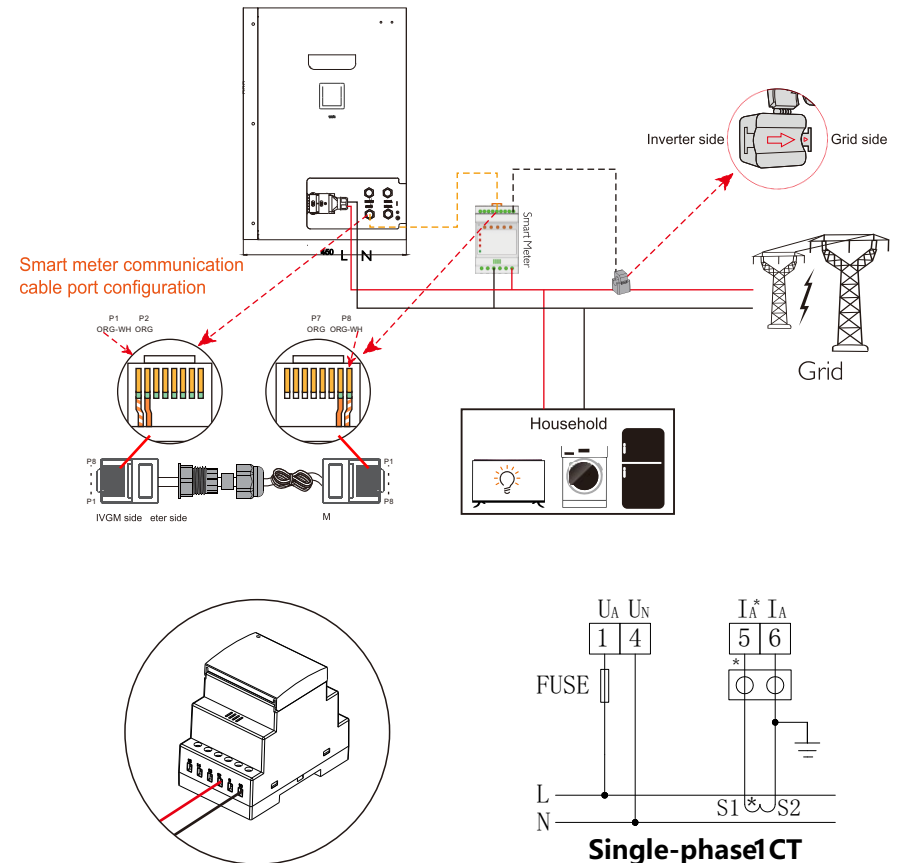

The Meter communication line is included in the package. Please connect the COM PORT and the RS485 on the meter.

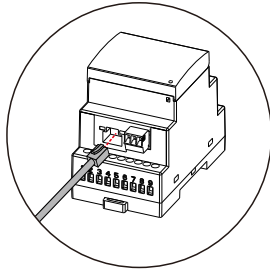

If you need further operation condition of inverter via RS485 communication, please See Table follow.

Position	Function	Note	
1	/	/	
2	/		
3	+VCC	Power Supply	
4	COM-GND		
5	RS485-B1	Lithium Battery Communication	
6	RS485-A1		
7	CANL1		
8	CANH1		

Please install the CT on the Live Wire (L) at the system grid connection point and the arrow on the CT needs to point to the grid direction.

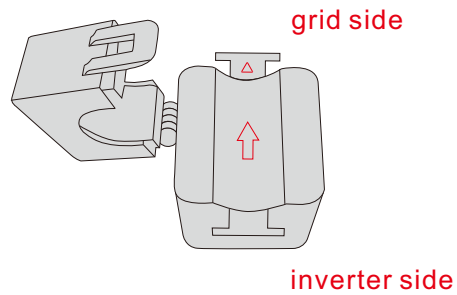

The Meter communication line is included in the package. Please connect the COM PORT and the RS485 on the meter.

STATUS	OFF	ON	Blinking
Run (Green)	The instrument is not running	/	The instrument is running normally
Com (Red)	The instrument is not communicating	/	The instrument is in communication status
R-P (Red)	Positive power	Negative power	/
(Red)	/	Negative value indicator lamp	/

3.9 DRMS connection (optional)

In Australia and New Zealand, the AS/NZS 4777.2:2020 required inverter needs to support Demand Response Mode (DRM). FelicityESS inverter support remote shutdown function to remotely control the inverter to power on and off through logic signals. The DRM port is provided with an RJ45 terminal and its Pin5 and Pin6 can be used for remote shutdown function. Our inverter has integrated a terminal block for connecting to a Demand Response Enabling Device (DRED)

Wiring Connection Procedure:

Step 1: Unscrew the nut from DRMS port.

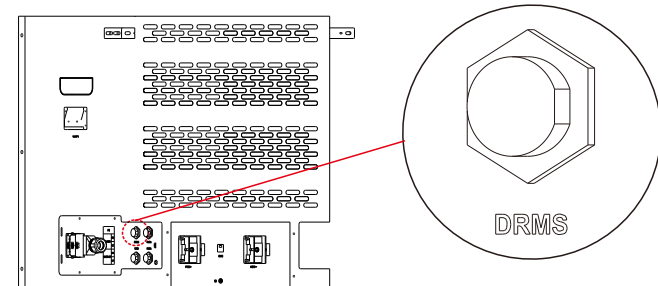

Step 2: Plug out the RJ45 terminal and dismantle the resistor on it. Plug the resistor out, leave the RJ45 terminal for next step.

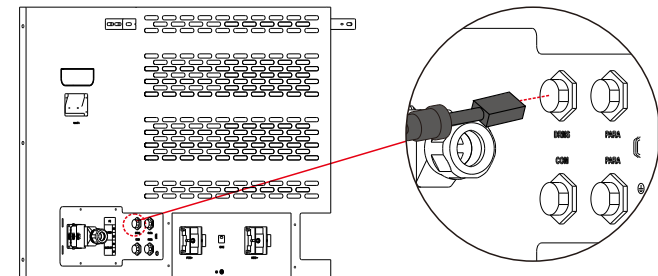

NOTE

•The RJ45 terminal in the inverter has the same function as DRED.
Please leave it in the inverter if no external device is connected.

Step 3 Pass the RJ45 cable through the steel plate and connect the DRED cable to the RJ45 terminal. Pin port definition is shown in Figure.

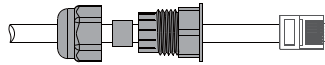

"DRM" Connector Pin Definition

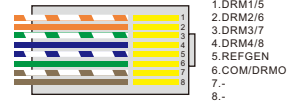

Mode	
DRM0	Operation disconnect device.
DRM1	Do not consume power
DRM2	Do not consume more than 50% of rated power
DRM3	Do not consume more than 75% of rated power AND Source reactive power if capable
DRM4	Increase power consumption (subject to constraints from other active DRMs)
DRM5	Do not generate power
DRM6	Do not generate more than 50%% of rated power
DRM7	Do not generate more than 75% of rated power AND absorb reactive power if capable
DRM8	Increase power generation (subject to constraints from other active DRMs)

NOTE Demand response modes of Table 3, 1 are as described in AS/NZS 4755.3 series of Standards.

Step 4 Plug the wires into the DRMS port on the inverter. Fasten the swivel nut and connect the other end to the DRED. (DRED is not provided by FELICITYESS)

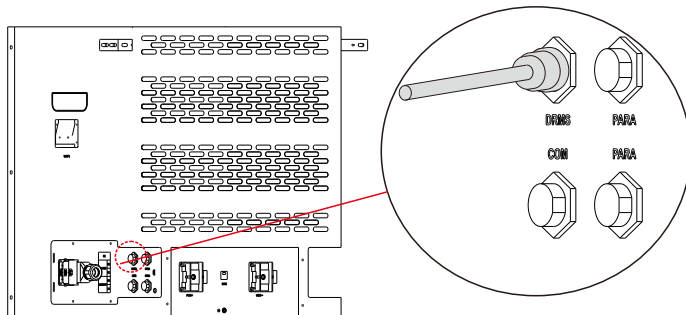

3.10 WIFI module installation and Monitoring

The ESS can be remotely monitored by APP and website via WIFI or 4G. If there is no WIFI, using 4G signal may result in communication fees charged by local telecom.

Step 1: Remove the waterproof lid from the Wi-Fi/4G terminal (On the top side of the inverter)

Step 2: Insert the Wi-Fi stick into the communication port. Slightly shake it by hand to determine whether it is installed firmly.

Step 3: Build the connection between the inverter and router. Please refer to section 4.3 to configure the WLAN with APP.

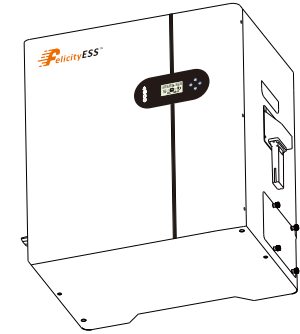
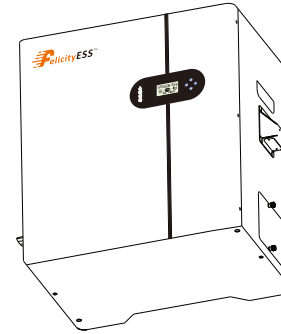

The ESS can be remotely monitored by APP and website via WIFI or 4G. If there is no WIFI, using 4G signal may result in communication fees charged by local telecom.

Step 1: Remove the waterproof lid from the Wi-Fi/4G terminal (On the top side of the inverter)

Step 2: Insert the Wi-Fi stick into the communication port. Slightly shake it by hand to determine whether it is installed firmly.

Step 3: Build the connection between the inverter and router. Please refer to section 4.3 to configure the WLAN with APP.

4. Commissioning and operation

4.1 Display panel and basic operation

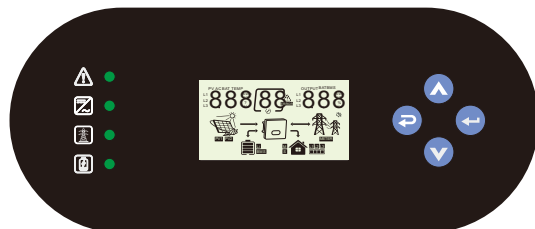

Function Key	Icon	Description
ESC		Hold on the "ESC" button last for 3S to turn off the inveter
UP		To go to previous selection
DOWN		To go to next selection
ENTER		Hold on the "ENTER" button last for 3S to turn on the inveter
LED Indicator	Icon	Description
Battery		Charging the battery, the LED light flash. If battery is full, the LED light will always-on. The battery is not charged, the LED light will go out.
Utility		Inverter running in utility mode, the LED will always-on. Inverter is not running in utility mode, the LED light will go out.
Inverter		Inverter running in off-grid mode, the LED light will always-on. Inverter is not running in off-grid mode, the LED light will go out.
Fault		If inverter in fault event, the LED light will always-on. If inverter in warning event, the LED light will flash. Inverter work normally, the LED light will go out.
Buzzer Information		
Buzzer beep	Turn on/off the inverter, the buzzer will last for 2.5s. Press any button, the buzzer will last for 0.1s. Hold on the "ENTER" button, the buzzer will last for 3s. If in fault event, the buzzer will keep going. If in warning event, the buzzer will beep discontinuous (Check more information on the chapter of "Warning Code Table").	

- 1.Switch the battery power break to on, press the power key
- 2.Please press the [ENTER] key for 3 second to power on the inverter.
- 3.Switch the PV power to on.



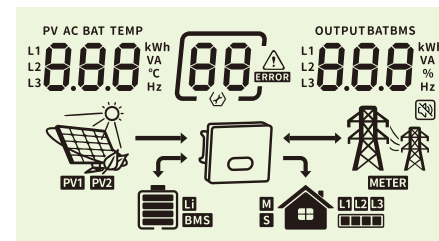

Power off:

- 1.Switch the PV power to off.
- 2.Switch the battery power break to off, press the power key
- 3.Press the [ESC] key for 3 second to power off and pull down the breaker.

4.2 LCD display

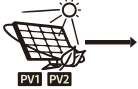

Icon	Function description
Input Source Information	
	Indicate input voltage, input frequency, PV voltage, PV power, battery voltage and charger current. 1.L1,L2,L3 with AC means phase1,phase2,phase3;with PV means series1,series2. 2.When it shows AC, you can check the AC voltage/frequency. When it shows PV you can check the PV power and voltage. When it shows BAT, u can check the charging current, battery voltage,
Configuration Program and Fault Information	
	Indicates the warning and fault codes. Warning: flashing with warning code. Fault: lighting with fault code Here shows the detail warning and fault number. The description and shooting are in chapter 8.
Output Information	
	Indicate output voltage, output frequency, load percent, load in VA, load in Watt and discharging current.
Battery Information	
	Indicates battery level by 0-24%, 25-49%, 50-74% and 75-100%.
	Indicates Lithium battery type.
	Indicates communication is built between inverter and battery.
Mode Operation Information	
	Indicates the utility.

	Indicates load level by 1-25%,26-50%,51-75% and 76-100%
	Indicates the PV panels.
	Indicates PV MPPT is working.
METER	Indicates communication is built between inverter and meter
Mute Operation	
	Indicates unit alarm is disabled.

The base information will be switched by pressing [UP] or [DOWN]

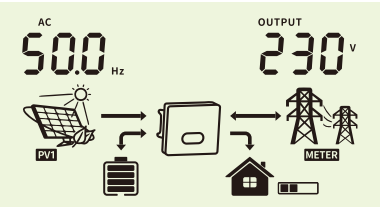
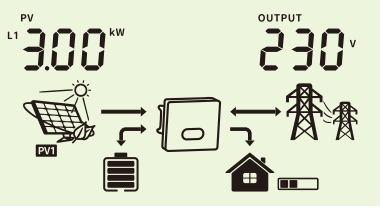
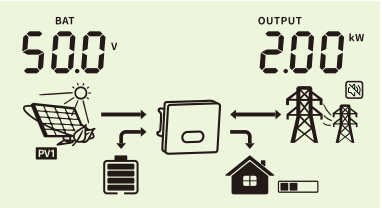
Example	Information
	Utility frequency 50Hz Inverter output 230V Battery DOC 100% Load level 50% 1 PV MPPT working, with meter.
	PV2 power is 3.00KW Inverter output 230V Battery DOC 100% Load level 50% 1 PV MPPT working, No meter
	Battery voltage 50.0V Output 2.00KW Battery DOC 100% Load level 50% 1 PV MPPT working, No meter Alarm disabled

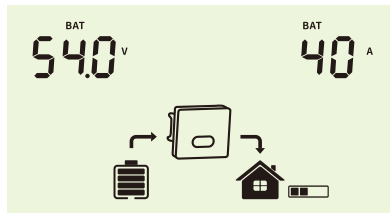
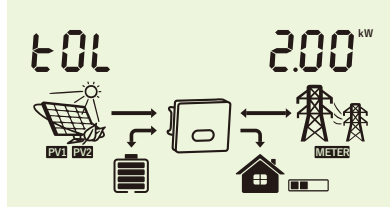
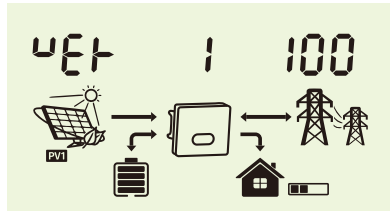
	Battery voltage 54.0V Battery discharging current 40A No utility, no PV, Battery DOC 100% Load level 50%
	Total load power 2.00KW
	CPU software version is 1100

4.3 Setup with APP

This is an intelligent cloud platform, enables users to achieve information management of photovoltaic plants. It equips users with real-time monitoring, plant, and device management, as well as remote control and intelligent alarm functionalities. You can log in account at any time through a computer, IOS or Android to achieve real-time display and remote control.

Monitoring web: <https://shine.felicityess.com>

APP: Search [FSOLAR] on Google Play store or Apple App Store. OR scan the following QR code.



The settings of APP are often updated, so we have made a web version of the manual. Please refer the F solar End User Manual, register the installer and create a plant and owner (skip this step if you already have an account.). you can obtain the manual by ourwebsite (<http://om.felicityess.com/home/>) or scan the QR code.



5.Parallel System Wiring (Optional)

5.1 Introduction to Parallel Machines

If you want to extend the power of the ESS system, it can be used in parallel. When multiple system are connecting in parallel, ONLY SAME MODEL (same power rating) can be used.

The system can be used in parallel in two different operating modes:

- (1) Single-phase parallel connection for use, supports 2 ~ 6 units in parallel. 6 units in parallel to support the maximum output power of 30KW/30KVA.
 - (2) Three-phase parallel connection for use, supports up to 6 units in parallel, the lowest 3 units in parallel, 6 units in parallel to support the maximum output power of 30KW/30KVA., up to 12KW per phase.
- to 20KW/20KVA.

5.2 Parallel installation specification

- (1) Please refer to sections 3.3 and 3.4 for the top and bottom distances of inverter parallel installation and the installation distances on both sides of multiple inverters.

Note: In order to make the inverter better heat dissipation, please make sure that the installation spacing of each inverter is in accordance with the specification of single installation, please pay attention to the phase sequence connection when installing the input and output power wires, pay attention to the installation of waterproof cover and the ground wire when threading the wires.

- (2) The detailed connection of the CAN communication connector is described below.

Step 1: Open the waterproof cover of the PARA port (show in the figure) of all the inverters in the parallel system.

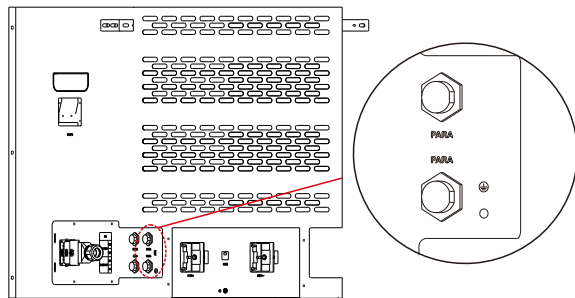

Step 2: The PARA ports from first inverter to the last inverter of the parallel system are connected by e CAN communication connector.

5.3 Single phase 230V parallel connection

- (1) All input and output power lines of the inverter should connect to the bus through the circuit breaker and are connected in phase sequence, do not connect the AC input neutral (N) to the AC output neutral (N) of another inverter.
- (2) Before the parallel system is powered up and started, please make sure that the battery negative poles of each inverter are connected together, and each inverter make sure that the parallel mode is set.

The wiring of two parallel:

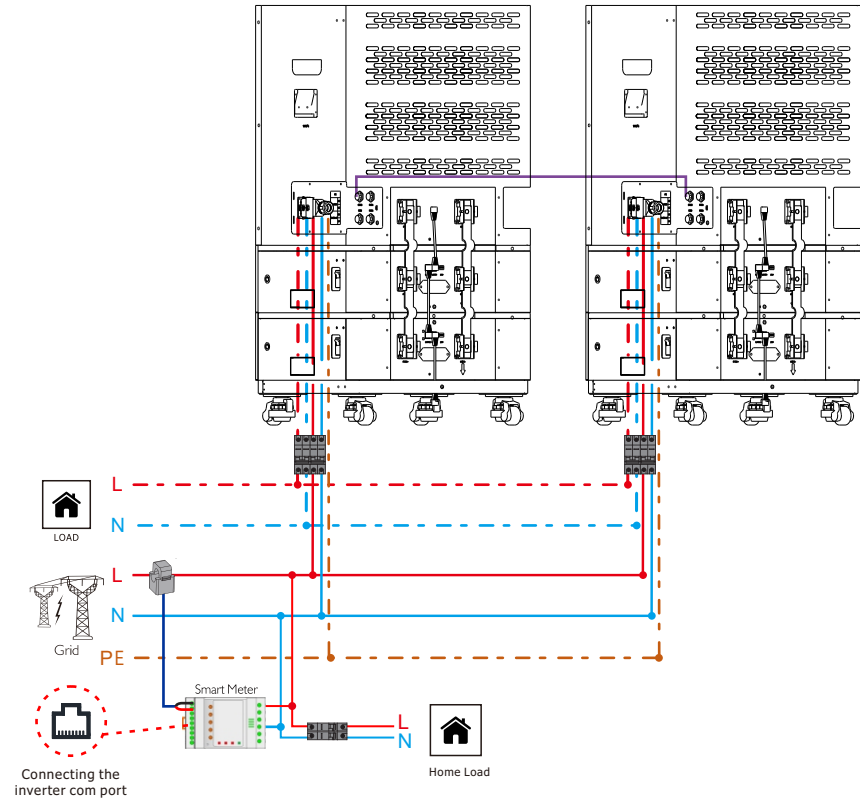

- (1) Load site: 40A AC breaker; Grid site: 63A AC breaker.
- (2) The PARA ports of the first and last inverters are plugged into the Parallel connector.
- (3) The storage battery BMS communication cable can be connected to any machine that has been powered up in the parallel system, (refer to section 3.6 for battery wiring).
- (4) For PV module wiring, please refer to sections 3.5 for PV connection. Note that each group of PV panels is only allowed to be connected into one machine.

The wiring of 3 parallel :

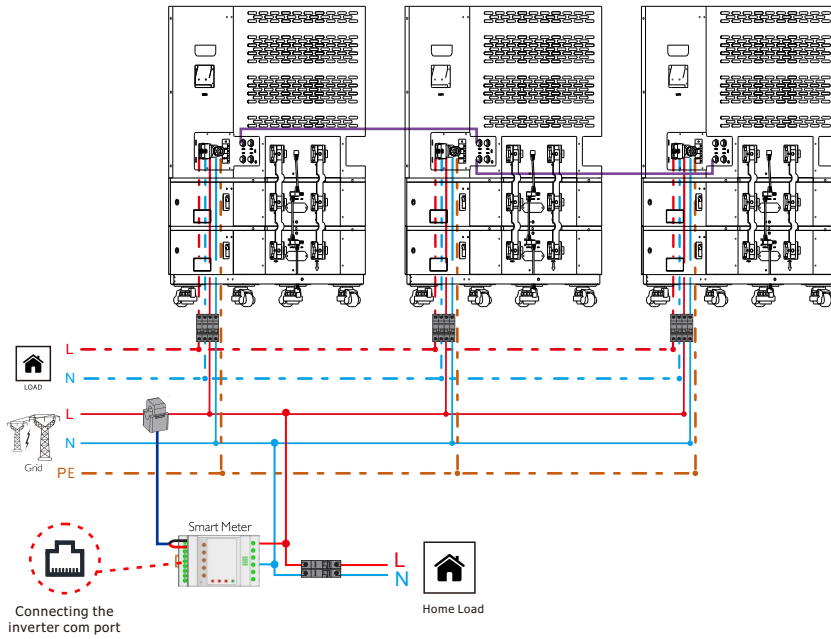

- (1) Load site: 40A AC breaker; Grid site: 63A AC breaker.
- (2) The PARA ports of the first and last inverters are plugged into the Parallel connector.
- (3) The storage battery BMS communication cable can be connected to any machine that has been powered up in the parallel system, (refer to section 3.6 for battery wiring).
- (4) For PV module wiring, please refer to sections 3.5 for connection. Note that each group of PV panels is only allowed to be connected into one machine.

The wiring of multiple parallel:

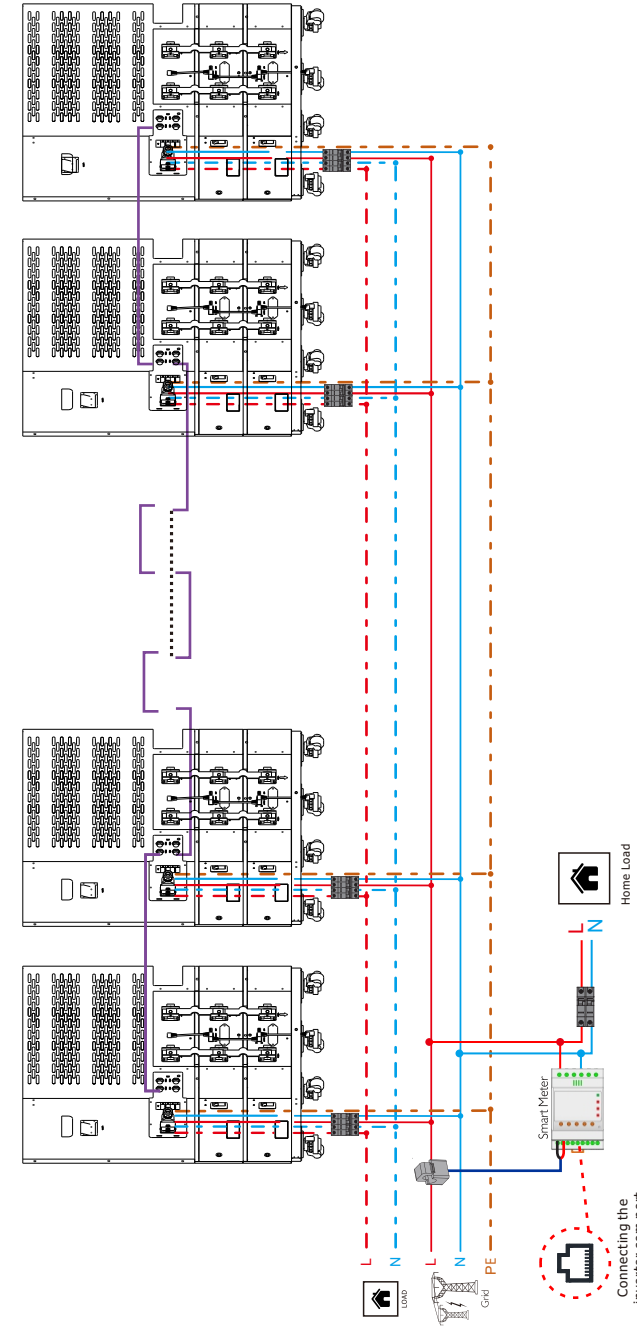

- (1) Load site: 40A AC breaker; Grid site: 63A AC breaker.
- (2) The PARA ports of the first and last inverters are plugged into the Parallel connector.
- (3) The storage battery BMS communication cable can be connected to any machine that has been powered up in the parallel system, (refer to section 3.6 for battery wiring).
- (4) For PV module wiring, please refer to sections 3.5 for connection. Note that each group of PV panels is only allowed to be connected into one machine.

5.4 Three phases 230V parallel connection

Notes:

- (1) All input and output power wires of the inverter are connected to the bus through the circuit breaker and are connected in phase sequence.
- (2) Before the parallel system is powered up and started, please make sure that the battery negative poles of each inverter are connected together, and each inverter make sure that the parallel mode is set.
- (3) Do not connect power cables between inverters set to different phases as this may damage the inverter.
- (4) Do not connect the AC input neutral (N) to the AC output neutral (N) of another inverter.

The wiring of 3 inverter parallel of three phases:

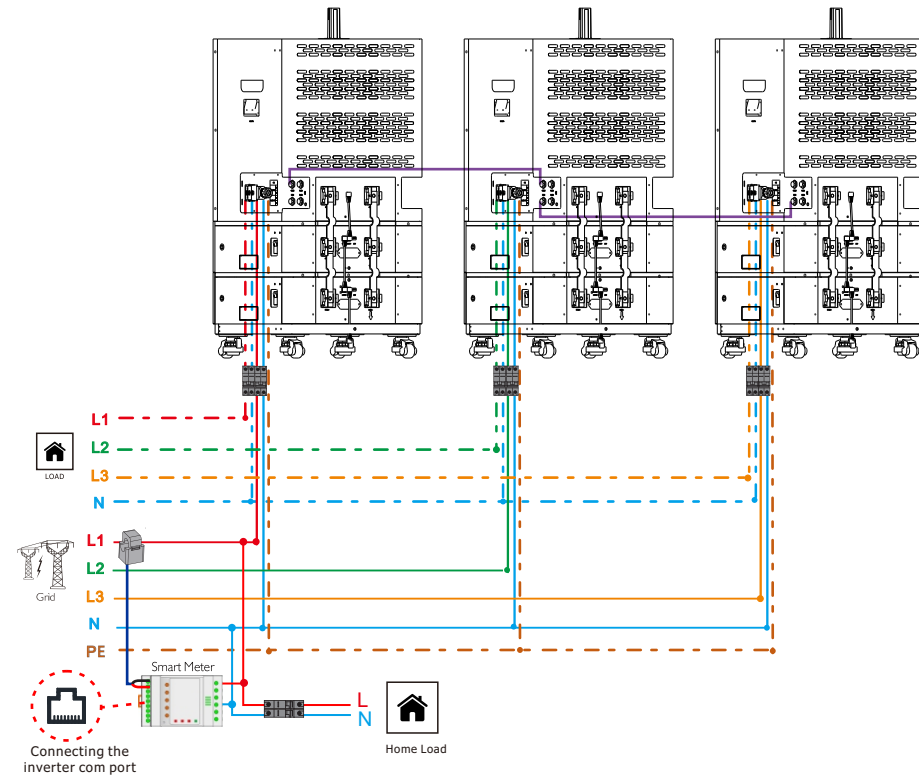

- (1) Load site: 40AAC breaker; Grid site: 63AAC breaker.
- (2) The PARA ports of the first and last inverters are plugged into the Parallel connector.
- (3) The storage battery BMS communication cable can be connected to any machine that has been powered up in the parallel system, (refer to section 3.6 for battery wiring).
- (4) For PV module wiring, please refer to sections 3.5 for connection. Note that each group of PV panels is only allowed to be connected into one machine.

The wiring of 6 inverter parallel of three phase:

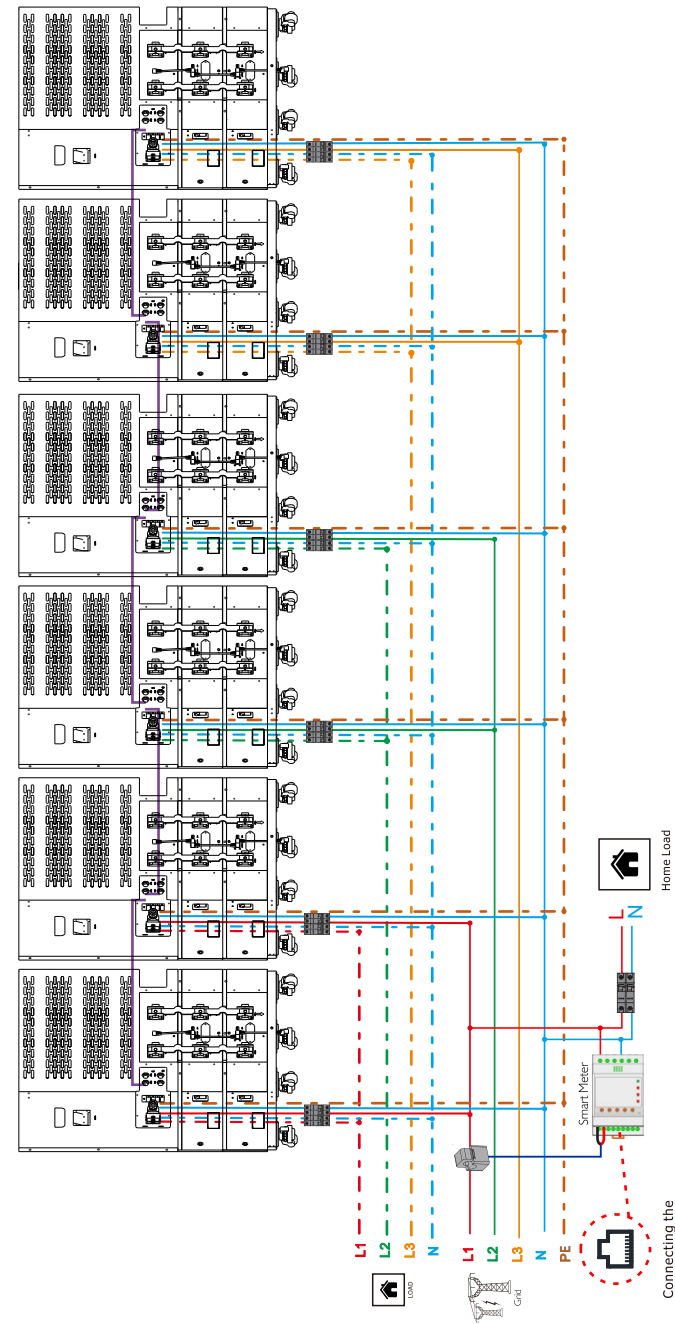

- (1) Load site: 40AAC breaker; Grid site: 63AAC breaker.
- (2) The PARA ports of the first and last inverters are plugged into the Parallel connector.
- (3) The storage battery BMS communication cable can be connected to any machine that has been powered up in the parallel system, (refer to section 3.6 for battery wiring).
- (4) For PV module wiring, please refer to sections 3.5 for connection. Note that each group of PV panels is only allowed to be connected into one machine.

5.5 LCD Manual setting parallel Mode

Note:

(1) Single-phase systems and three-phase systems manually set parallel mode step 1,2,3,6 have the same process, step.4 is the single-phase parallel setup process, and steps 5 is the three-phase parallel setup process.

(2) You can only choose Single-phase mode or three-phase parallel mode.

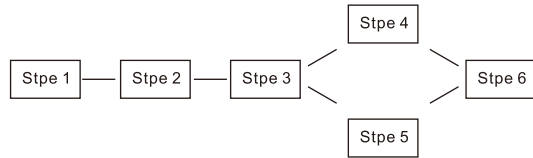

STEP 1 The machine should be set in standby when setting the parallel mode, otherwise the setting can not be done, The LCD displays the standby condition as shown in the figure below.

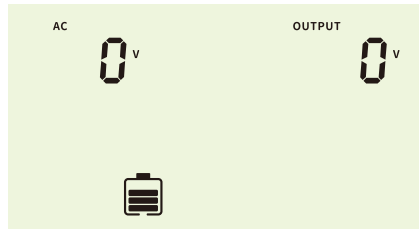

STEP 2 Simultaneously press and hold the display panel up and down keys until it enters the setting mode, The LCD display enters as shown below.

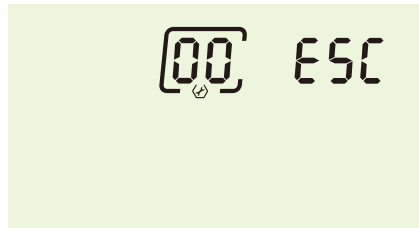

STEP 3 . Press Up or Down key to switch the option until the interface shows 28, then press Enter key to enter the parallel mode selection, The LCD display entry options and mode selections are shown below :

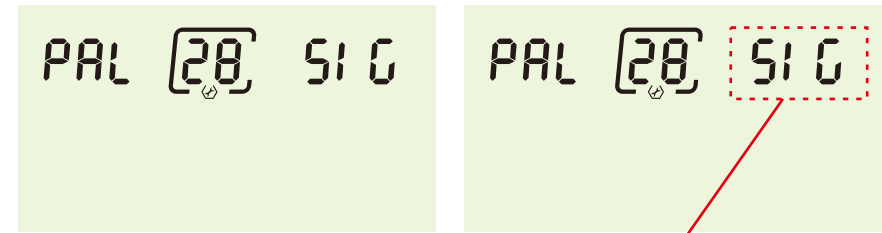

Mode Selection

STEP 4. Parallel single-phase system:

Press up or down key to switch mode, parallel single-phase system mode select PAL, then press Enter key to set. The LCD displays the parallel single-phase system mode as shown below. Each machine in parallel needs to be set consistently.

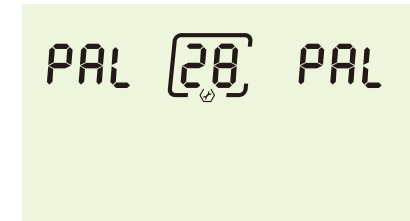

STEP 5. Parallel three-phase system:

Press the up or down key to switch the mode, parallel three phase system of each phase line corresponding to the machine in the parallel mode selection to select L1 or L2 or L3, the three cannot be duplicated the settings. Selection is completed by pressing the [Enter] key to set up. The LCD displays the mode selection for each phase of a parallel three-phase system as shown below. Note: The phase lines of the corresponding inverters should all be set to the same. After the stand-alone machine is successfully powered on to set the mode, a warning code 25 will appear on the LCD screen, which is a normal phenomenon. After few minutes, it will disappear.

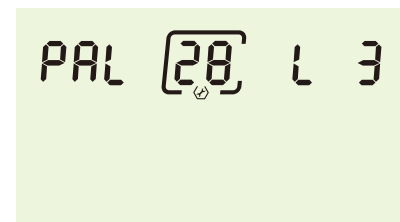
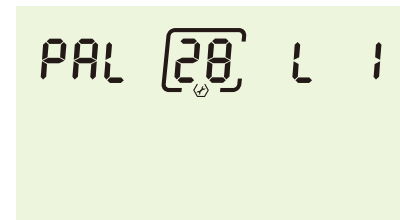

STEP.6 After the above settings are completed, press the [ESC] key to exit. Then the machine enters the standby interface and then long press [Enter] key to enter the inverter output state, the inverter can be powered off and shut down. If a three-phase parallel system into the inverter output mode, a 25 warning will appear on the LCD screen, please don't worry, this is normal. Each inverter set up after the completion of the parallel mode need to ensure that the inverter into the inverter output mode. The LCD shows the inverter entering the inverter output mode as shown below.

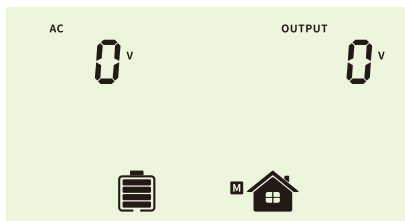

After all the above inverters have been set up, all inverters are powered on and running.

6. Maintenance

Felicity All in one ESS system doesn't need any regular maintenance. However, cleaning the heatsink will help the inverter dissipate heat and increase the lifetime of inverter. The dirt on the inverter can be cleaned with a soft brush. The Screen and the LED status indicator lights can be cleaned with cloth if they are too dirty to be read.



CAUTION:

Do not touch the surface when the inverter is operating. Some parts may be hot and could cause burns, Turn OFE the inverter and let it cool down before you do any maintenance or cleaning of inverter.



NOTE:

Never use any solvents, abrasives, or corrosive materials to clean the inverter.

If you get troubles in using the inverter, please contact our local sales team or technical support.

7. Warning Code Table

When the fault event happens, the error warning icon will flash.

Some codes for R&D or maintenance only will not show here. Here is some common warning code.

Warning Code	Warning Information	Audible Alarm	Trouble Shooting
07	Low battery		The battery voltage is too low, it should be charging.
09	Overload	Beep twice every second	Reduce the loads.
25	Phase Sequence Errors		Check that the input and output power lines correspond
51	BMS doesn't allow inverter to discharge battery.		Inverter will stop discharging battery automatically.
52	BMS require inverter to charge battery.		Inverter will charge battery automatically.
60	BMS firmware version is not matched.		Upgrade the firmware of BMS.

8. Troubleshooting

When the fault event happens, the repair warning icon will flash

This chapter describes the fault code for quick troubleshooting



NOTE:

If the inverter displays any alarm message as listed in Table 8.1; please turn off the inverter and wait for 5 minutes before restarting it. If the failure persists, please contact your local distributor or the service center.

Fault Code	Fault information	Trouble Shooting
01	PV voltage is too high	Reduce the number of Pv modules in series.
02	Over current happen at PV port	Restart the unit, if the error happens again, please return to repair center.
04	Stort circuit happen at PV port	Check if wiring is connect well.
06	Pv current sensor failed	Restart the unit, if the error happens again, please return to repair center.
07	Battery voltage is too high	Check if spec and quantity of batteries are meet requirements.
10	Abnormal LLC	Restart the unit, if the error happens again, please return to repair center.
11	Over current happen at Buckboost	Restart the unit, if the error happens again, please return to repair center.

14	BuckBoost is out of balance	Restart the unit, if the error happens again, please return to repair center.
15	Buckboost current sensor failed	Restart the unit, if the error happens again, please return to repair center.
16	NO.2 Buckboost current sensor failed	Restart the unit, if the error happens again, please return to repair center.
17	Overload time out	Reduce the connected load by switching off some equipment.
19	Output short circuited	Check if wiring is connected well and remove abnormal load.
20	Input output reverse	Confirm that the input and output wiring is correct.
21	OP current sensor failed	Output current sensor failed
22	Output voltage is too low	Reduce the connected load.
23	Output voltage is too high	Restart the unit, if the error happens again, please return to repair center.
24	Over current or surge detected by Software	Restart the unit, if the error happens again, please return to repair center.
25	Hardware detect over current at inverter port	Restart the unit, if the error happens again, please return to repair center.
26	Invert soft start failed	Internal components failed. Restart the unit, if the error happens again, please return to repair center.
28	The DC component of the inverter current is abnormal	Restart the unit, if the error happens again, please return to repair center.
29	Inverter current sensor failed	Restart the unit, if the error happens again, please return to repair center.
30	Bus voltage is too low	Restart the unit, if the error happens again, please return to repair center.
31	Bus voltage is too high	AC Surge or internal components failed. Restart the unit, if the error happens again, please return to repair center.
33	Bus soft start failed	Internal components failed. Restart the unit, if the error happens again, please return to repair center.
34	Over temperature happen at heat sink	Check whether the ambient temperature is too high.
35	The inner temperature over	Check whether the ambient temperature is too high.
38	Leakage current fault	Restart the unit, if the error happens again, please return to repair center.
39	Leakage current sensor failed	Restart the unit, if the error happens again, please return to repair center.

40	Isolation resistance to ground of the PV string is too low	Restart the unit, if the error happens again, please return to repair center.
42	Relay check failure	Restart the unit, if the error happens again, please return to repair center.
43	Parallel CAN COMM abnormality	Test the parallel communication line, restart still have problems please contact the after-sales service.
44	Loss of parallel hosts	
45	Parallel Synchronisation Signal Abnormal	
46	Inconsistency in parallel versions	1. Update all inverter firmware to the same version. 2. Check the version of each inverter via the LCD settings to ensure that the CPU versions are the same. If it is not the same, please contact after-sales personnel to update the firmware. 3. After updating, if the problem still exists, please contact after-sales.
47	Inconsistent parallel settings	Single-phase parallel system and group three-phase system setup error
48	Failure of the parallel system as a whole	Specific faults in other machines in the parallel system
49	Parallel negative power protection	Restart the unit, if the error happens again, please return to repair center.
50	EEPROM failure	Restart the unit, if the error happens again, please return to repair center.
51	DSP1 communication failure	Restart the unit, if the error happens again, please return to repair center.
52	DSP2 communication failure	Restart the unit, if the error happens again, please return to repair center.
53	PV parallel failure	Please confirm whether PV1 and PV2 need to be set to parallel mode. If not, please turn off this function in APP. If necessary, please confirm whether the wiring of PV1 and PV2 is connected to parallel mode.
54	Temperature sensor disconnected	Restart the unit, if the error happens again, please return to repair center.
87	Battery input circuit failure	Restart the unit, if the error happens again, please return to repair center.