



# USER GUIDE

T-REX-3KLP1G01/3K6LP1G01/  
4KLP1G01/4K6LP1G01/  
5KLP1G01/6KLP1G01

*Hybrid inverter*



# Contents

<b>1. SAFETY &amp; WARNING</b> .....	2
<b>2 Product Introduction</b> .....	2
2.1 Products overview .....	3
<b>3 Installation</b> .....	4
3.1 Packing List.....	4
3.2 Installation tools .....	5
3.3 Installation Environment .....	5
3.4 Mounting .....	7
<b>4. Electrical Connection</b> .....	8
4.1 PV Connection .....	8
4.2 Battery Connection.....	9
4.3 On-Grid & Back-Up Connection .....	10
4.4 Smart Meter & CT Connection .....	13
4.5 DRMS Connection .....	15
4.6 Lithium Battery Communication .....	17
4.7 Installation of WiFi module .....	18
4.8 Wiring System .....	19
<b>5. Display and operation</b> .....	20
5.1 Operation and Display Panel.....	20
5.2 LCD Display Icons.....	21
5.3 Base information Page.....	22
<b>6. Work Mode</b> .....	24
<b>7. Parallel installation</b> .....	27
7.1 Introduction to Parallel Machines .....	27
7.2 Parallel installation specification .....	27
7.3 Single-phase 230v Parallel connection .....	27
7.4 three-phase parallel connection .....	31
7.5 LCD Manual Setting Parallel Mode.....	35
<b>8. Warning Code Table</b> .....	37
<b>9. Troubleshooting</b> .....	37
<b>10. Appendix</b> .....	40

## About This Manual

The manual mainly describes the product information, guidelines for installation, operation and maintenance. The manual cannot include complete information about the photovoltaic (PV) system.

## How to Use This Manual

Read the manual and other related documents before performing any operation on the inverter. Documents must be stored carefully and be available at all times. Contents may be periodically updated or revised due to product development. The information in this manual is subject to change without notice. The latest manual can be acquired via our website at <https://www.felicityess.com> for latest version.









## Safety Introductions

This chapter contains important safety and operating instructions. Read and keep this manual for future reference.

- Before using the inverter, please read the instructions and warning signs of the battery and corresponding sections in the instruction manual.
- Do not disassemble the inverter. If you need maintenance or repair, take it to a professional service center.
- Improper reassembly may result in electric shock or fire.
- To reduce risk of electric shock, disconnect all wires before attempting any maintenance or cleaning. Turning off the unit will not reduce this risk.
- Caution: Only qualified personnel can install this device with battery.
- Never charge a frozen battery.
- For optimum operation of this inverter, please follow required specification to select appropriate cable size. It is very important to correctly operate this inverter.
- Be very cautious when working with metal tools on or around batteries. Dropping a tool may cause a spark or short circuit in batteries or other electrical parts, even cause an explosion.
- Please strictly follow installation procedure when you want to disconnect AC or DC terminals. Please refer to "Installation" section of this manual for the details.
- Grounding instructions - this inverter should be connected to a permanent grounded wiring system. Be sure to comply with local requirements and regulation to install this inverter.
- Never cause AC output and DC input short circuited. Do not connect to the mains when DC input short circuits.

## 1. SAFETY & WARNING

This manual provides relevant information with icons to highlight the physical and property safety of the user to avoid device damage and physical injury. The Symbols used in this manual are listed as below:

Symbols	Name	Instruction
	Danger	Serious physical injury or even death may occur if not follow the relative requirements
	Warning	Physical injury or damage to the devices may occur if not follow the relative requirements
	Electrostatic sensitive	Damage may occur if not follow the relative requirements
	Hot surface	Sides of the device may become hot. Do not touch.
	Earth terminal	The inverter must be reliably grounded.
	Caution	Ensure that DC and AC side circuit breakers have been disconnected and wait at least 5 minutes before wiring and checking.
NOTE	Note	The procedures taken for ensuring proper operation.
	CE mark	The inverter complies with the CE directive.
	EU WEEE mark	Product should not be disposed as household waste.

## 2. Product Introduction

FelicityESS T-REX-3KLP1G01/T-REX-3K6LP1G01/T-REX-4KLP1G01/T-REX-4K6LP1G01/T-REX-5KLP1G01/T-REX-6KLP1G01 is a multifunctional inverter, combining functions of inverter, solar charger and battery charger to offer uninterruptible power support with portable size. Its comprehensive LCD display offers user configurable and easy accessible button operation such as battery charging, AC/solar charging, and acceptable input voltage based on different applications.

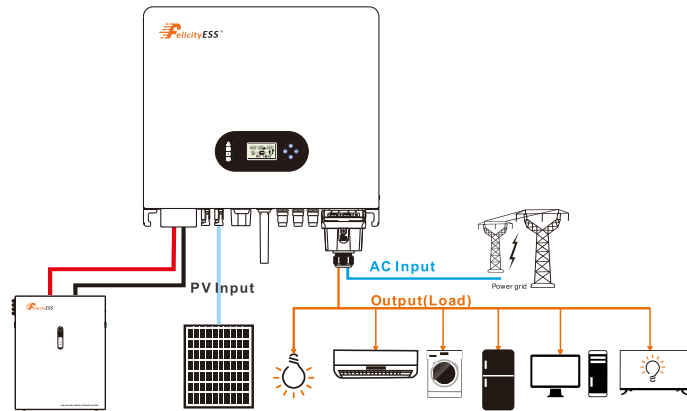

Figure 2 Block diagram of hybrid solar inverter system

## 2.1 Products overview

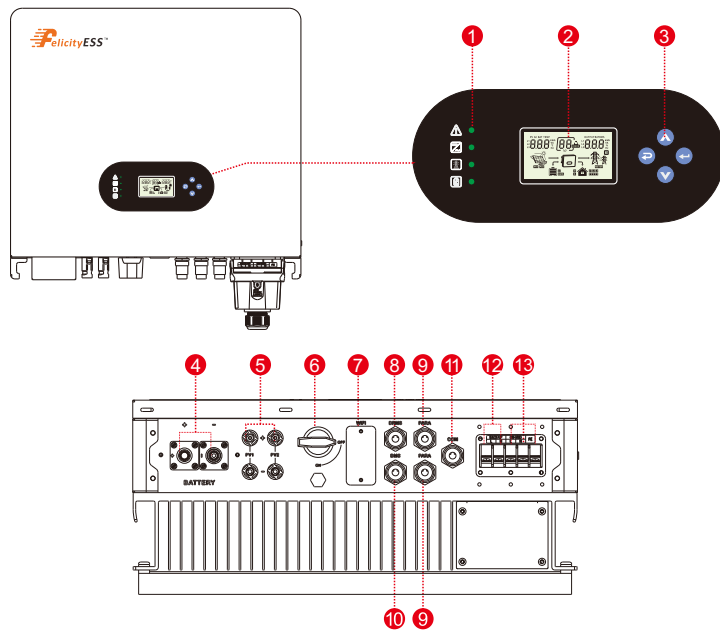

Figure 2.1-1 Products overview

- |                             |                            |                      |
|-----------------------------|----------------------------|----------------------|
| 1. Inverter Indicators      | 6. DC switch               | 10. BMS port         |
| 2. LCD display              | 7. WIFI Communication port | 11. COM port         |
| 3. Button                   | 8. DRMS port               | 12. Back-up terminal |
| 4. Battery connection port  | 9. PARA port               | 13. On-grid terminal |
| 5. PV input connection port |                            |                      |

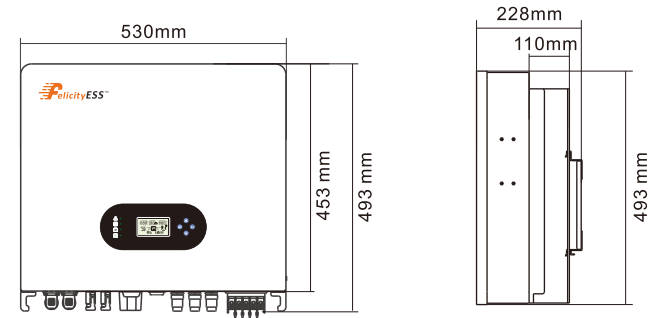

Figure 2.1-2 Inverter dimensions

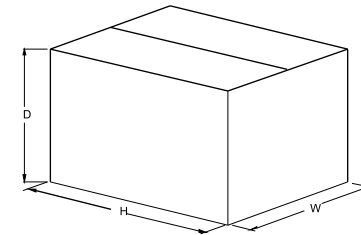

Figure 2.1-3 Paper packages dimension

Table 2.1-3 Packages dimension and gross weight

Model	H (mm)	W (mm)	D (mm)	Net Weight (KG)	Gross Weight (KG)
T-REX-3KLP1G01/T-REX-3K6LP1G01	632	570	315	32.4	39.1
T-REX-4KLP1G01/T-REX-4K6LP1G01					
T-REX-5KLP1G01/T-REX-6KLP1G01					

## 3 Installation

### 3.1 Packing List

The inverter 100% strictly inspected before package and delivery. Please check the product package and fittings carefully before installation.

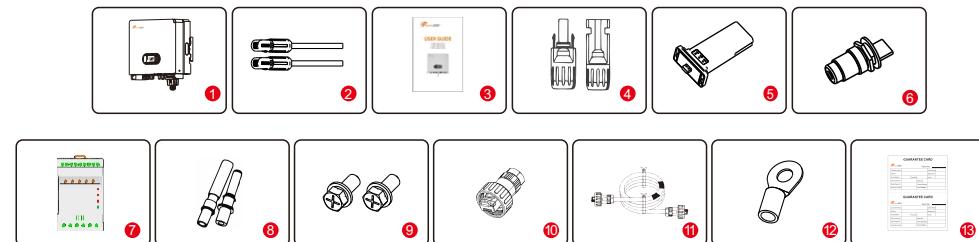

Figure 3.1-1 Packing List



Table 3.1-1 Detailed delivery list

No.	Name	Quantity
1	Inverter	1
2	Battery connector	1 pair
3	Operation manual	1
4	DC connector	2 pairs
5	WiFi module	1
6	COM connector	2
7	Meter+CT(Optional)	1
8	Expansion Bolts	4
9	M5 combination screw	2
10	Parallel connector	1
11	Parallel cable	1
12	OT terminals	6
13	Guarantee card	1

## 3.2 Installation tools



Figure 3.2-1 Installation tools

## 3.3 Installation Environment

- ◇ Choose a dry, clean, and tidy place, convenient for installation
- ◇ Ambient temperature range: -25°C ~ 60°C
- ◇ Relative humidity: 0 ~ 100% (non-condensed)
- ◇ Install in a well-ventilated place
- ◇ No flammable or explosive materials close to inverter
- ◇ The AC overvoltage category of inverter is category III
- ◇ Maximum altitude: 2000m



• Inverter cannot be installed near flammable, explosive or strong electro-magnetic equipment.

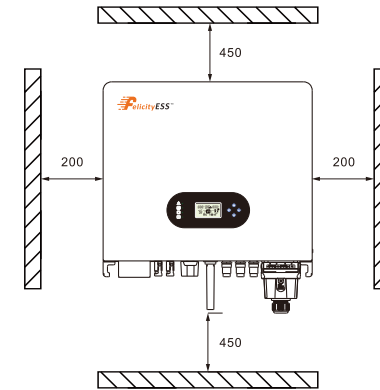

Figure 3.3-1 Installation space of one inverter

Ensure there is sufficient space for heat-releasing. Generally, space requirement should be met as below:

Table 3-3-1 Detailed installation space

	Minimum clearance
Lateral	200mm
Top	450mm
Bottom	450mm

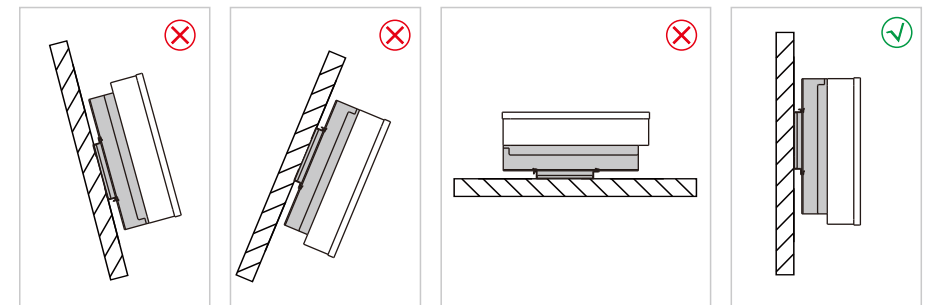

Figure 3.3-2 Installation position



• Do not open the cover of the inverter or replace any part as incomplete inverter may cause electric shock and damage the device during operation.

The installation of inverter should be protected under shelter from direct sunlight or badweather like snow,rain, lightning etc.

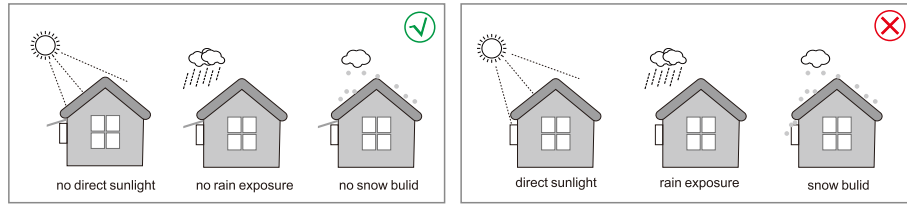

Figure 3.3-3 Installation position

## 3.4 Mounting



•The inverter is heavy, please be careful when removing it from the package.

The inverter is suitable for mounting on concrete or other non-combustible surface only.

**Step 1.** Please use the mounting bracket as a template to drill 4 holes in the right positions (10mm in diameter,and 80mm in depth). Use M8 expansion bolts in accessory box and fix the mounting With a 12mm drill bracket onto the wall tightly.The installation of inverter support is shown in Figure 3.4-1.

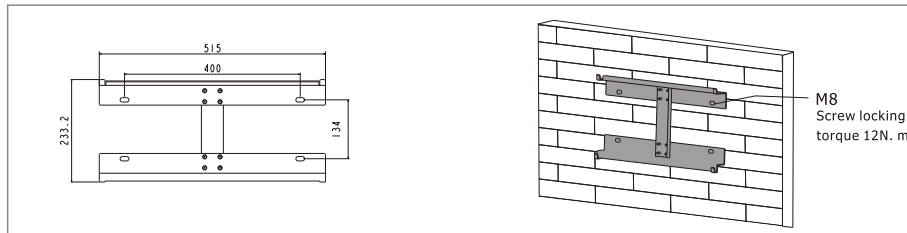

Figure 3.4-1 Install the inverter hanging plate

**Step 2.** Lift the inverter to fix it on the installation bracket, We can prevent theft by locking. See Figure 3.4-2.

NOTE

•Be careful when mounting because the inverter is very heavy.

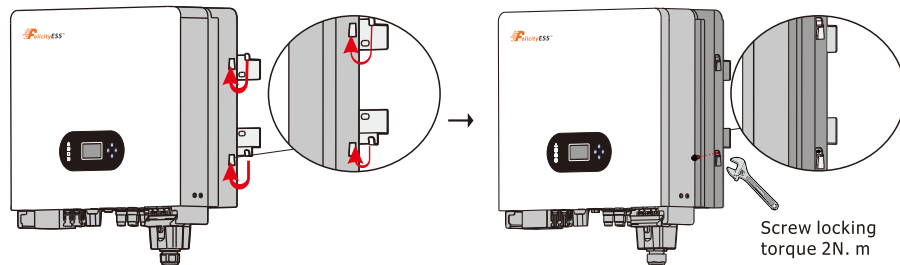
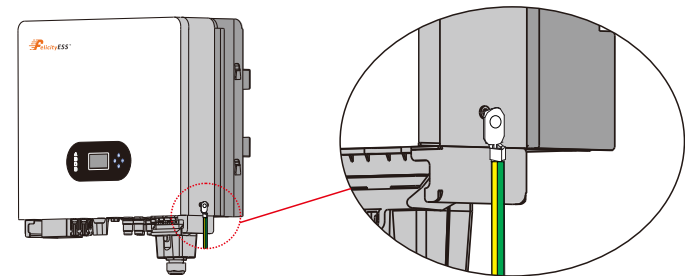

Figure 3.4-2 Installing an Inverter



Screw locking torque 2N. m

Figure 3.4-3 Rack earth(Ground wire locked by M5)

## 4 Electrical Connection

- ◇High voltages in power conversion circuits. Lethal hazard of electric shock or serious burns.
- ◇All work on the PV modules, inverters, and battery systems must be carried out by qualified personnel only.
- ◇Wear rubber gloves and protective clothing (protective glasses and boots) when working on high voltage/high current systems such as INVERTER and battery systems.

### 4.1 PV Connection

Before connecting PV panels/strings , please make sure requirements are followed as below:

- (1)The total short-circuit current of PV string must not exceed inverter's max DC current.
- (2)The minimum isolation resistance to ground of the PV string must exceed 19.33kΩ in case of any shock hazard.
- (3)PV string could not connect to earth/grounding conductor.
- (4) Use the right PV plugs in the accessory box.

Wire Size	Cable(mm)
10~12AWG	7

**Step 1.** Prepare PV positive and negative power cables

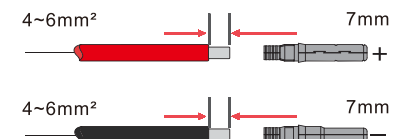
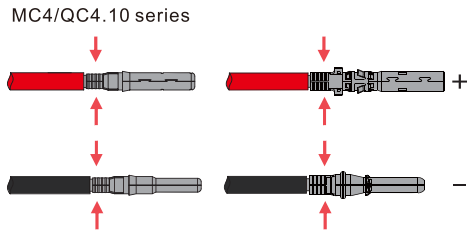

Figure 4.1-1 pv cables and pv plugs

**Step 2.** Connect PV cables to PV connectors. See Figure 4.1-2.

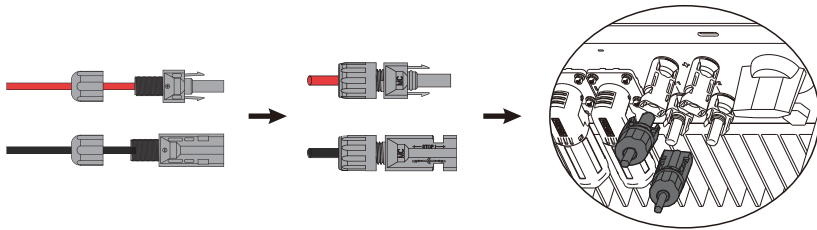

**Figure 4.1-2 PV cables to PV connectors**

**NOTE**

- PV cables must be tightly crimped into the connectors.
- For Amphenol connector, the limit buckle cannot be pressed.
- There will be a "click" sound if connectors are inserted correctly into PV plugs.

**Step 3.** Screw the cap on and plug it onto inverter side. There will be a click sound if connectors are inserted correctly into PV plugs. See Figure 4.1-3.



**Figure 4.1-3 The PV plug is connected to the inverter**



- The polarity of PV strings cannot be connected reversely, otherwise the inverter could be damaged.

## 4.2 Battery Connection

Please be careful about any electric shock or chemical hazard. Make sure there is an external DC breaker (125A) connected to the battery without build-in DC breaker.



- The polarity of battery cannot be connected reversely, otherwise the inverter could be damaged.

Inverter Model	Wire Size	Strip length
T-REX-3KLP1G01/T-REX-3K6LP1G01 T-REX-4K6LP1G01/T-REX-4K6LP1G01 T-REX-5KLP1G01	4AWG/25mm <sup>2</sup>	15mm
T-REX-6KLP1G01	3AWG/26.67mm <sup>2</sup>	

**Step 1.** Prepare battery cables and accessories, and route the battery power cable through the battery cover. Use accessories box accessories, and cut the battery power cable according to the model.

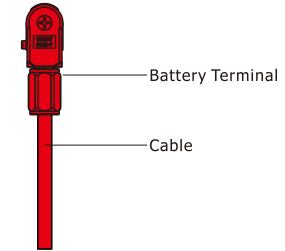

**Figure 4.2-1 Battery cable and battery case**

**Step 2.** Make battery terminals. Strip cable coat. Use special crimper to compress battery terminal tightly.

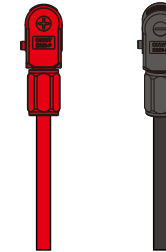

**Figure 4.2-2 The battery terminal**

**Step 3.** Connect the battery terminal to the inverter. Ensure that the battery polarity is connected correctly.

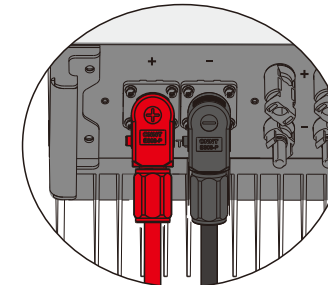

**Figure 4.2-3 The battery terminal is connected to the inverter**

## 4.3 On-Grid & Back-Up Connection

An external AC breaker is needed for on-grid connection to isolate from grid when necessary. The requirements of on-grid AC breaker are shown as below.

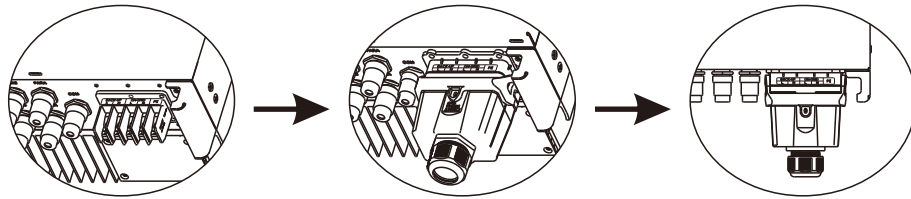

Figure 4.3-1 Install AC cables for the inverter



• Don't connect the PE wire wrong.

Table 4.3-1 : Recommended table of AC circuit breakers

INVERTER MODEL	AC BREAKER SPECIFICATION
T-REX-3KLP1G01/T-REX-3K6LP1G01/T-REX-4KLP1G01 T-REX-4K6LP1G01/T-REX-5KLP1G01/T-REX-6KLP1G01	40A/230V,2P

NOTE

• The absence of AC breaker on back-up side will lead to inverter damage if an electrical short circuit happens on back-up side.

1. On the AC side, the individual breaker should be connected between inverter and Grid but before loads. See Figure 4.3-2.

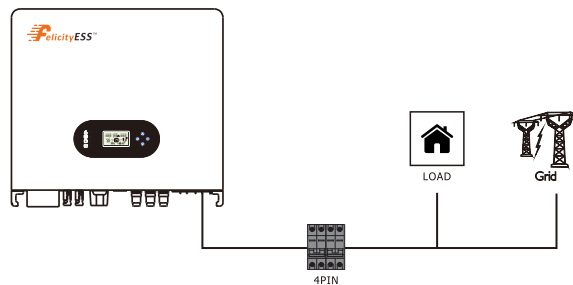

Figure 4.3-2 Ac breaker connection



• Make sure the inverter is totally isolated from any DC or AC power before connecting AC cable.

Step 1. Prepare the terminals and AC cables as below. See Figure 4.3-3.



Figure 4.3-3 Ac connection line

Table 4.3-2 : Ac cable specifications

Grade	Description	Value
A	Outside diameter	13-18 mm
B	Separated wire length	20-25 mm
C	Conductor wire length	7-9 mm
D	Conductor core section	4-6 mm

Step 2. Using the terminals in the accessory box, pass the AC cable through the terminal cover. See Figure 4.3-4.

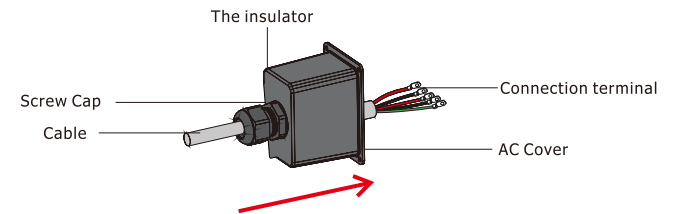

Figure 4.3-4 The AC cable passes through the terminal cover

Step 3. Install the AC connection terminal on the cable. See Figure 4.3-5.

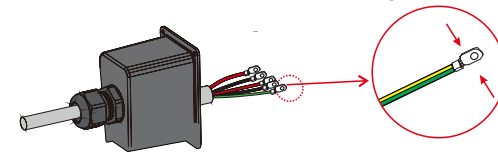

Figure 4.3-5 Install ac connection terminals

NOTE

• The absence of AC breaker on back-up side will lead to inverter damage if an electrical short circuit happens on back-up side.

Step 4. Connect the combined AC cable to the AC terminal of the inverter, tighten the cable to a torque of 2.0 N.m to 2.5 N.m, and then lock the AC cover. See Figure 4.3-6.

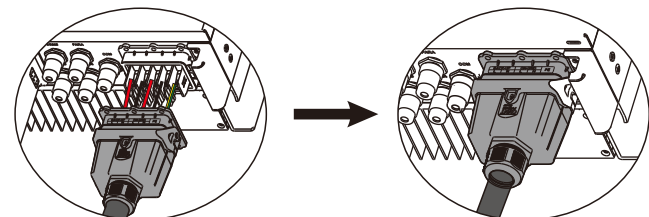

Figure 4.3-6 Install ac connection terminals

### 4.4 Smart Meter & CT Connection

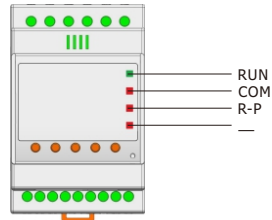

Figure 4.4-1 Smart Meter

Table 4.4-1 :Smart Meter LED Indications

STATUS	OFF	ON	Blinking
Run (Green)	The instrument is not running	/	The instrument is running normally
Com (Red)	The instrument is not communicating	/	The instrument is in communication status
R-P (Red)	Positive power	Negative power	/
- (Red)	/	Negative value indicator lamp	/

Connection Mode

The connection diagram on the instrument housing shall prevail in case of any discrepancies with it.

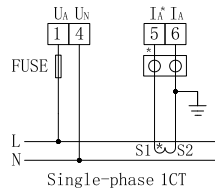

It is recommended to use 0.5A or 3A for the fuse in the connection diagram;



•Make sure the inverter is totally isolated from any DC or AC power before connecting AC cable.



Figure 4.4-2 RS485 interface

Table 4.4-2 :RS485 interface

NO.	8	7	6	5	4	3	2	1
Function	485A	485B	485A	GND1	GND1	485B	NC	NC

The Smart Meter with CT in product box is compulsory for T-REX system installation, used to detect grid voltage and current direction and magnitude, further to instruct the operation condition of T-REX inverter via RS485 communication. See Table 4.4-3.

Table 4.4-3 :Detailed Pin Function Of COM Port On T-REX

Position	Function	Note	
1	485_A2	RS485-2 For Meter	
2	485_B2		
3	485_A3	RS485-3 For Remote Monitor	
4	485_B3		
5	485_B3		
6	485_A3	Dry Signal	
7	RY_4		
8	RY_5		

**Note :** The cable should be made refer to Figure 4.4-4

Make sure Meter & CT are connected between house loads and grid, and follow the Smart Meter direction sign on CT, refer to Figure 4.4-4.

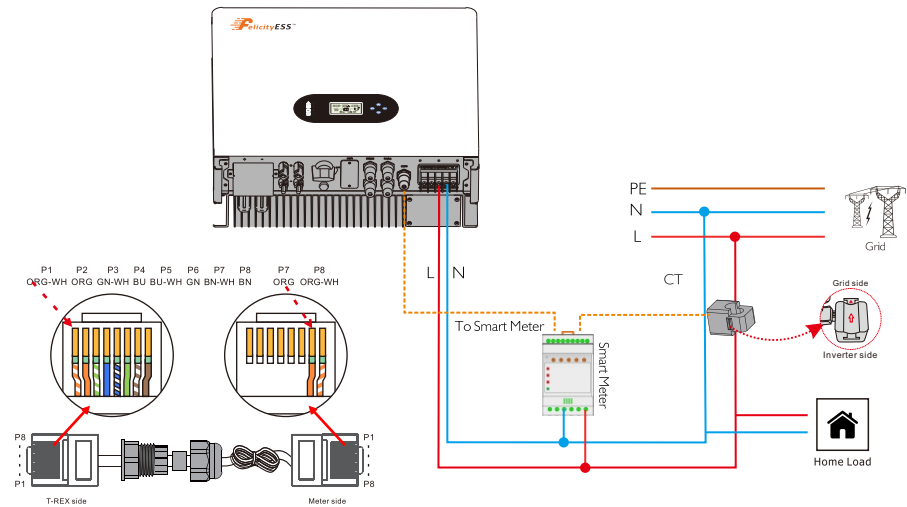

Figure 4.4-4 Smart meter connection

### 4.5 DRMS Connection

DRMS(Demand response enabling device) is used for Australia and New Zealand installation (also used as remote shutdown function in European countries), in compliance with Australia and New Zealand safety requirements( or European countries). Inverter integrates control logic and provides an interface for DRMS. The DRMS is not provided by inverter manufacturer. Detailed connection of DRMS & Remote Shutdown are shown below:

**Step 1.** Screw this plate off from the inverter. See Figure 4.5-1.

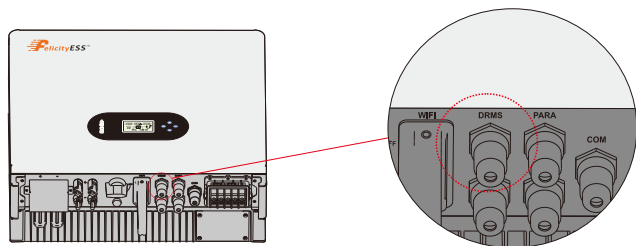

Figure 4.5-1 DRMS interface

**Step 2.** Plug out the RJ45 terminal and dismantle the resistor on it. Plug the resistor out, leave the RJ45 terminal for next step.

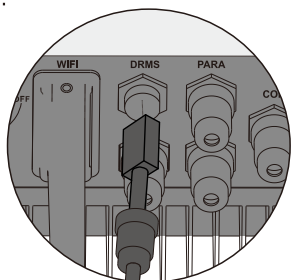

Figure 4.5-2 operating steps

**NOTE**

•The RJ45 terminal in the inverter has the same function as DRED. Please leave it in the inverter if no external device is connected.

**Step 3-1** Pass the RJ45 cable through the steel plate and connect the DRED cable to the RJ45 terminal. As shown in Figure 4.5-3, Table 4-9 describes the 6-pin port definition.

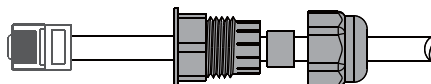

Figure 4.5-3 operating steps

Table 4.5-3 :Port pin allocation table

NO.	1	2	3	4	5	6	7	8
Function	DRM1/5	DRM2/6	DRM3/7	DRM4/8	REFGEN	COM/DRMO	-	-

**Step 3-2 For Remote Shutdown.** Run the cable through the steel plate . Then wire from pins 5 and 6. Table 4.6-1 describes the 6-pin port definition,Wiring is shown in Figure 4.5-4.

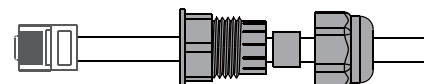

Figure 4.5-4 Remotely close the cable connection

**Step 4.** Connect RJ45 terminal to the right position onto the inverter.See Figure 4.5-5.

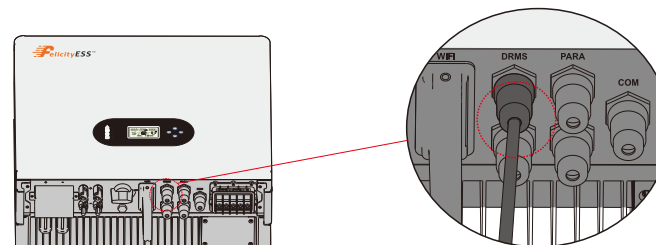

Figure 4.5-5 RJ45 interface

### 4.6 Lithium Battery Communication

It's allowed to connect lithium battery and build communication only which it has been configured. Please follow bellow steps to configure communication between lithium battery and inverter.

1. Connect power cables between lithium battery and inverter. Please pay attention to the terminals of positive and negative. Make sure the positive terminal of battery is connected to the positive terminal of inverter, and the negative terminal of battery is connected to the negative terminal of inverter.
2. The communication cable is bundled with lithium battery. Both sides are RJ45 port. One port is connected to the BMS port of inverter and another one is connected to the COMM port of lithium battery.

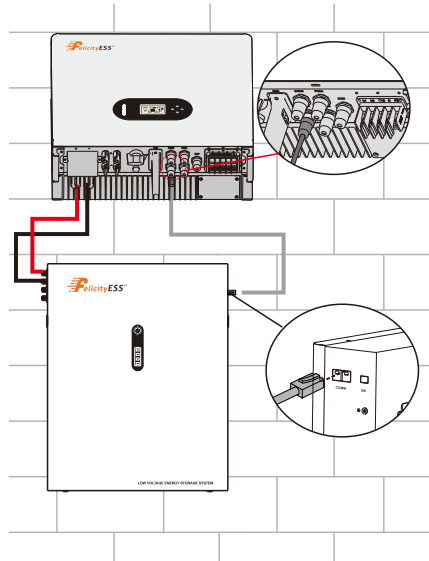

Table 4.6-1 :Detailed Pin Function Of BMS Port On T-REX

Position	Function	Note	
1	/	/	
2	/	/	
3	+VCC	Power Supply	
4	COM-GND		
5	RS485-B1	Lithium Battery Communication	
6	RS485-A1		
7	CANL1		
8	CANH1		

3. Configure battery type to lithium battery on the app



And then LCD will show you "Li" icon.

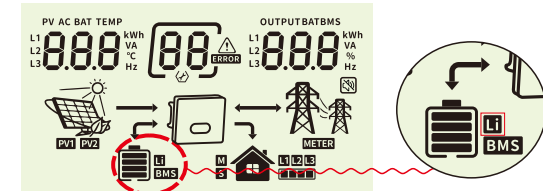

4. Power up lithium battery and inverter. Wait a moment, if the communication is built between them, LCD will show you "BMS" icon as below.

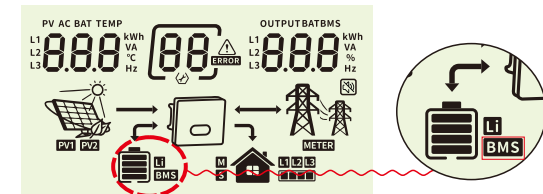

5. Roll LCD real time information pages by pressing "UP" or "DOWN" button, as below page, you can see the parameters of SOC, battery pack units and other informations in the communication system. LCD will be rolled these parameters or informations automatically.

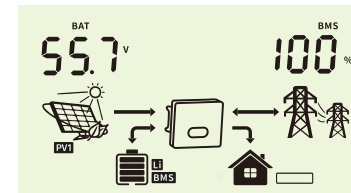

Battery SOC is 100%

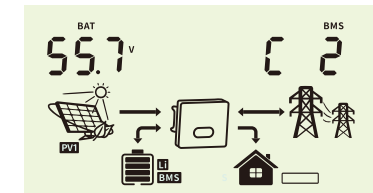

Battery pack units are 2

When it displays :

- "b50" means BMS doesn't allow inverter to charge battery
- "b51" means BMS doesn't allow inverter to discharge battery
- "b52" means BMS require inverter to charge battery

### 4.7 Installation of WIFI module

The WiFi communication function applies only to the WiFi module. For details, see Figure 4.7-1 installing a WiFi module.

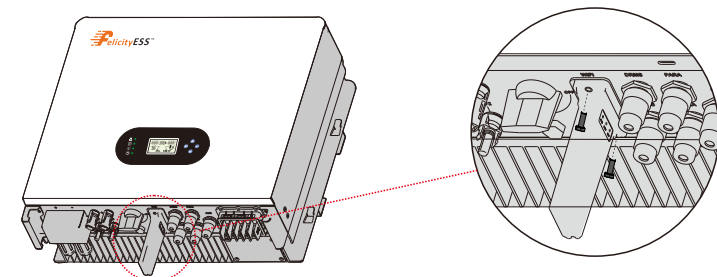

Figure 4.7-1 WiFi Module installation



### 4.8 Wiring System

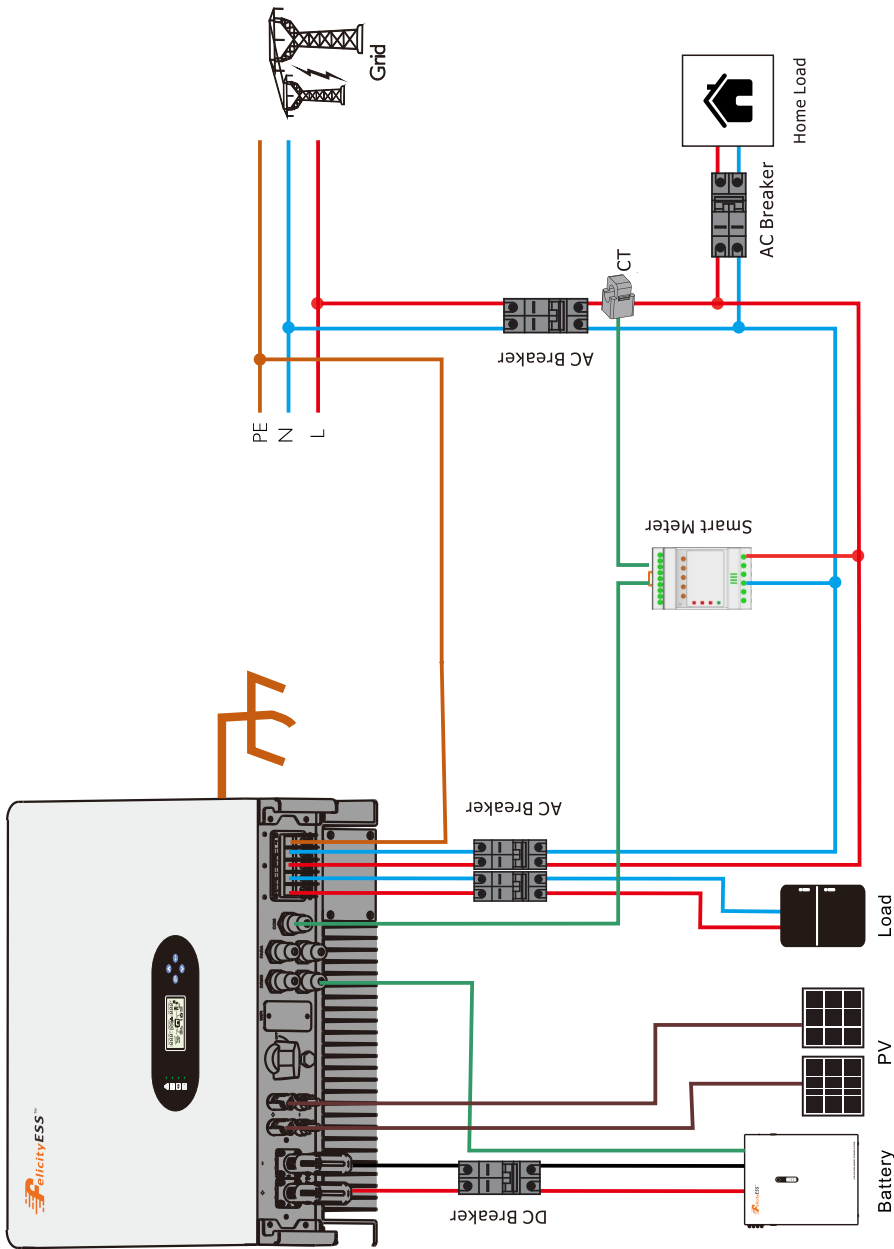
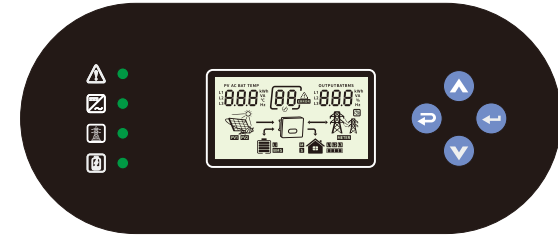

Figure 4.8-1 Inverter wiring system

### 5. Display and operation

This chapter describes the panel displaying and how to operate on the panel, which involves the LCD display, LED indicators and operation panel.

#### 5.1 Operation and Display Panel



Function Key	Icon	Description
ESC		Hold on the "ESC" button last for 3S to turn off the inveter
UP		To go to previous selection
DOWN		To go to next selection
ENTER		Hold on the "ENTER" button last for 3S to turn on the inveter
LED Indicator	Icon	Description
Battery		Charging the battery, the LED light flash. If battery is full, the LED light will always-on. The battery is not charged, the LED light will go out.
Utility		Inverter running in utility mode, the LED will always-on. Inverter is not running in utility mode, the LED will go out.
Inverter		Inverter running in off-grid mode, the LED light will always-on. Inverter is not running in off-grid mode, the LED light will go out.
Fault		If inverter in fault event, the LED light will always-on. If inverter in warning event, the LED light will flash. Inverter work normally, the LED light will go out.
Buzzer Information		
Buzzer beep		Turn on/off the inverter, the buzzer will last for 2.5s. Press any button, the buzzer will last for 0.1s. Hold on the "ENTER" button, the buzzer will last for 3s. If in fault event, the buzzer will keep going. If in warning event, the buzzer will beep discontinuous (Check more information on the chapter of "Warning Code Table").



### 5.2 LCD Display Icons

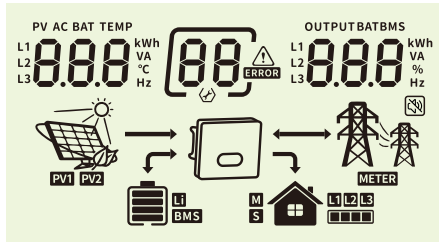

Icon	Function description
<b>Input Source Information</b>	
	Indicate input voltage, input frequency, PV voltage, PV power, battery voltage and charger current.
<b>Configuration Program and Fault Information</b>	
	Indicates the warning and fault codes. Warning:  flashing with warning code. Fault:  lighting with fault code
<b>Output Information</b>	
	Indicate output voltage, output frequency, load percent, load in VA, load in Watt and discharging current.
<b>Battery Information</b>	
	Indicates battery level by 0-24%, 25-49%, 50-74% and 75-100%.
	Indicates Lithium battery type.
	Indicates communication is built between inverter and battery.
<b>Mode Operation Information</b>	
	Indicates the utility.
	Indicates load level by 1-25%, 26-50%, 51-75% and 76-100%
	Indicates the PV panels.

	Indicates PV MPPT is working.
	Indicates communication is built between inverter and meter
<b>Mute Operation</b>	
	Indicates unit alarm is disabled.

### 5.3 Base information Page

The base information will be switched by pressing "UP" or "DOWN" key. The selectable information is switched as below order:

<p><b>Input voltage / Output voltage</b> Utility voltage is 230V, output voltage is 230V</p>	<p><b>Input frequency / Output voltage</b> Utility frequency is 50.0Hz, output voltage is 230V</p>
<p><b>PV1 voltage / Output voltage</b> PV1 voltage is 450V, output voltage is 230V</p>	<p><b>PV1 power / Output voltage</b> PV1 power is 3.00kW, output voltage is 230V</p>
<p><b>PV2 voltage / Output voltage</b> PV2 voltage is 450V, output voltage is 230V</p>	<p><b>PV2 power / Output voltage</b> PV2 power is 3.00kW, output voltage is 230V</p>

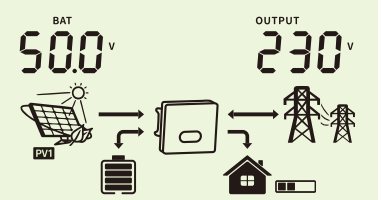
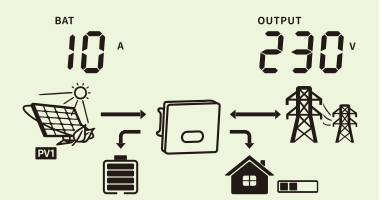
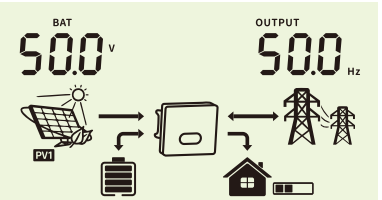
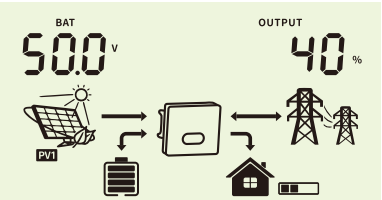
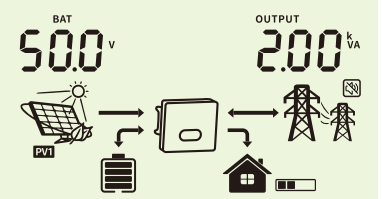
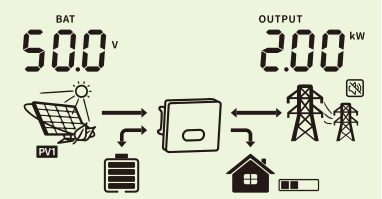
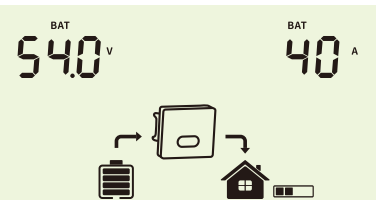
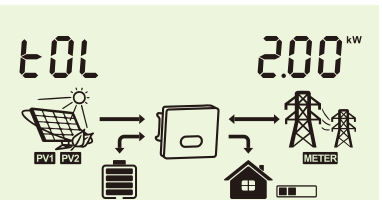
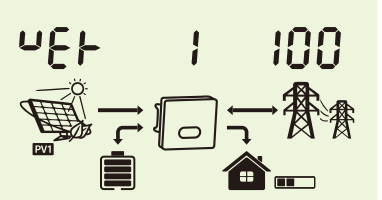
<p><b>Battery voltage / Output voltage</b> Battery voltage is 50.0V, output voltage is 230V</p> 	<p><b>Charging current / Output voltage</b> Charging current is 10A, output voltage is 230V</p> 
<p><b>Battery voltage / Output frequency</b> Battery voltage is 50.0V, output frequency is 50.0Hz</p> 	<p><b>Battery voltage / Load percentage</b> Battery voltage is 50.0V, load percentage is 40%</p> 
<p><b>Battery voltage / backup load VA</b> Battery voltage is 50.0V, backup load is 2.00kVA</p> 	<p><b>Battery voltage / backup load power</b> Battery voltage is 50.0V, backup load is 2.00kW</p> 
<p><b>Battery voltage / Discharging current</b> Battery voltage is 54.0V, discharging current is 40A</p> 	<p><b>Total load power</b> Total load power is 2.00kW</p> 
<p><b>CPU software version</b> CPU software version is 1100</p> 	

## 6. Work Mode

### General mode

In this mode, the priority order of load supply source is Solar>Battery>Grid. The priority order of solar power usage is Load>Battery>Grid. And only solar can charge the battery.

### Example:

Example1: PV<Load, PV and Bat will load at the same time. If PV+Bat cannot provide sufficient power to the load, the remaining energy will be provided from the Grid.

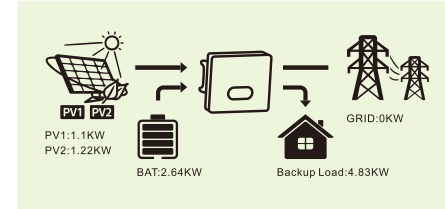

Example2: Load<PV<Load+BAT, PV provides power to Load first and the remaining energy will charge BAT.

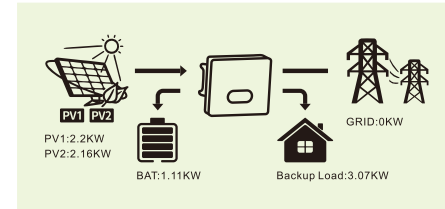

Example3: PV>Load+BAT, PV provides power to Load first, and then to BAT, and the remaining energy will be feed to the Grid.  
Energy Distribution Priority: Load>BAT>Grid

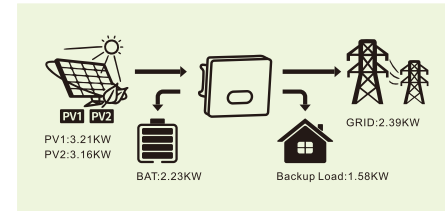

### Backup mode

The priority order of solar power usage will be Battery >Load >Grid. The priority order of load supply source is Solar>Grid>Battery. In this mode, the mains is not allowed to charge the battery.

Example1: PV<BAT, PV charges BAT first, and the remaining energy required for Load is provided by Grid.

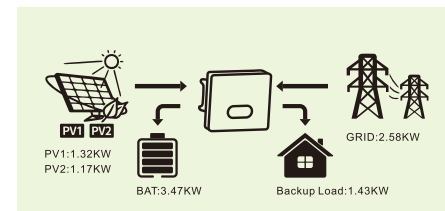

Example2:  $BAT < PV < Load + BAT$ , PV charges BAT first, and the remaining energy required for Load will be provided by Grid.

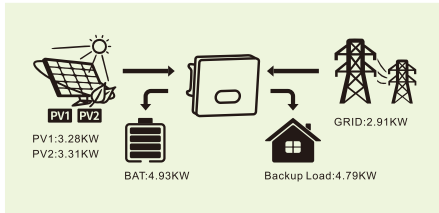

Example3:  $PV > Load + BAT$ , PV provides power to BAT first, and then to Load, and the remaining energy will be feed to the Grid.  
Energy Distribution Priority:  $BAT > Load > Grid$

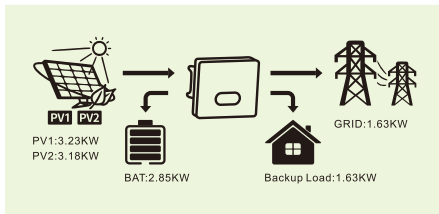

## ECO mode

During Charge Priority time period, load is first supplied with grid power. If there is excess solar power after battery charging, the excess solar power will take load together with grid power.  
During Discharge Priority time period, the priority order of load supply source is Solar > Battery > Grid. If there is excess solar power after load, charging battery, and then feed power to grid.

In charging mode:

Example1:  $PV < BAT$ , PV+Grid charges BAT, and the Grid will provide power to Load.

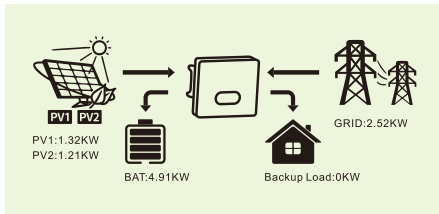

Example2:  $BAT < PV < BAT + Load$ , PV charges BAT first, and PV+Grid will provide power to Load.

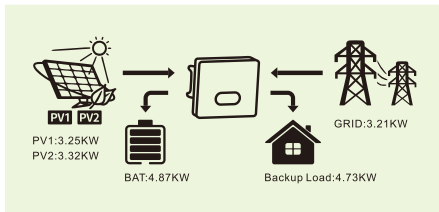

Example3:  $PV > Load + BAT$ , PV provides power to Load and BAT, and the remaining energy will be sent to the Grid.

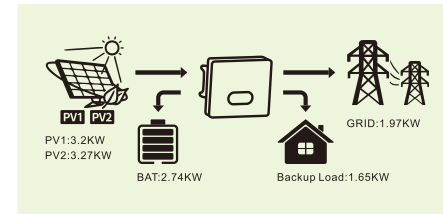

In discharging mode,

Example1:  $PV < Load$ , PV+BAT provide power to Load, BAT provides power to the Grid.

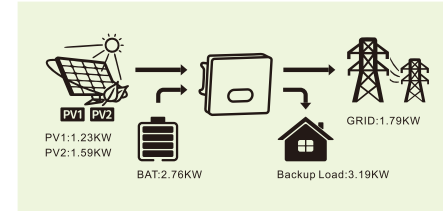

Example2:  $Load < PV < Load + BAT$ , PV provides power to Load first, PV+BAT will provide power to the Grid.

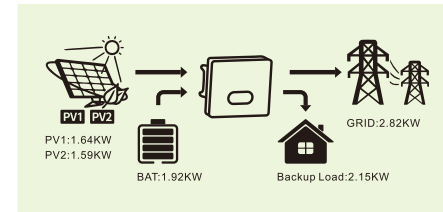

Example3:  $PV > Load + BAT$ , PV provides power to Load and Grid, and the remaining energy will charge BAT.

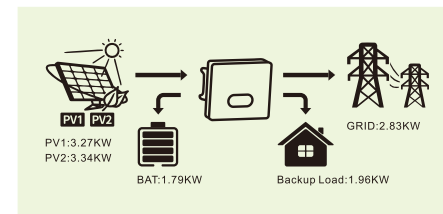

## Power Limit Function

The function could be realized by:

- (1) Make sure Smart Meter connection and communication well.
- (2) Turn on export power limit function and set the max output power to grid on App.

Note: Even if output power limit is set to 0W, there might still be a deviation of a max of 100W exporting to grid.

**Zero Export To Load:** Hybrid inverter will provide power to the backup load connected. The hybrid inverter will also provide power to the home load and sell power to grid by the function of Grid Power Limit setting. Smart Meter & CT Connection is not needed.

**Zero Export To CT:** Hybrid inverter will not only provide power to the backup load connected but also give power to the home load connected. If PV power and battery power is insufficient, it will take grid energy as supplement. In this mode, a Meter & CT is needed. The installation method of the Meter & CT please refer to chapter 4.4 Smart Meter & CT Connection.

**Grid Power Limit:** the maximum power feeds to Grid.

## 7. Parallel installation

### 7.1 Introduction to Parallel Machines

The inverter can be used in parallel in two different operating modes:

- (1) Single-phase parallel connection for use, supports up to 12 units in parallel, minimum 2 units in parallel, 12 units in parallel to support the maximum output power of 72KW/72KVA.
- (2) Three-phase parallel connection for use, supports up to 12 units in parallel, the lowest 3 units in parallel, 12 units in parallel to support the maximum output power of 72KW/72KVA, a phase up to 24KW/24KVA.

### 7.2 Parallel installation specification

(1) Please refer to sections 3.3 and 3.4 for the top and bottom distances of inverter parallel installation and the installation distances on both sides of multiple inverters.

Note: In order to make the inverter better heat dissipation, please make sure that the installation spacing of each inverter is in accordance with the specification of single installation, please pay attention to the phase sequence connection when installing the input and output power wires, and pay attention to the installation of waterproof cover and the ground wire when threading the wires.

(2) The detailed connection of the Parallel connector is described below.

**Step 1:** open the waterproof cover of the PARA port of the first inverter and the last inverter of the parallel system.

**Step 2:** The PARA ports of the first inverter and the last inverter of the parallel system are connected to the Parallel connector.

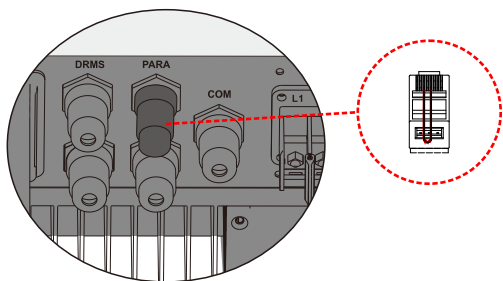

### 7.3 Single-phase 230v Parallel connection

Note:

- (1) All input and output power lines of the inverter are connected to the bus through the circuit breaker and are connected in phase sequence, do not connect the AC input neutral (N) to the AC output neutral (N).
- (2) Before the parallel system is powered up and started, please make sure that the battery negative poles of each inverter are connected together, and each inverter make sure that the parallel mode is set.

### 7.3.1 Parallel connection of two inverters

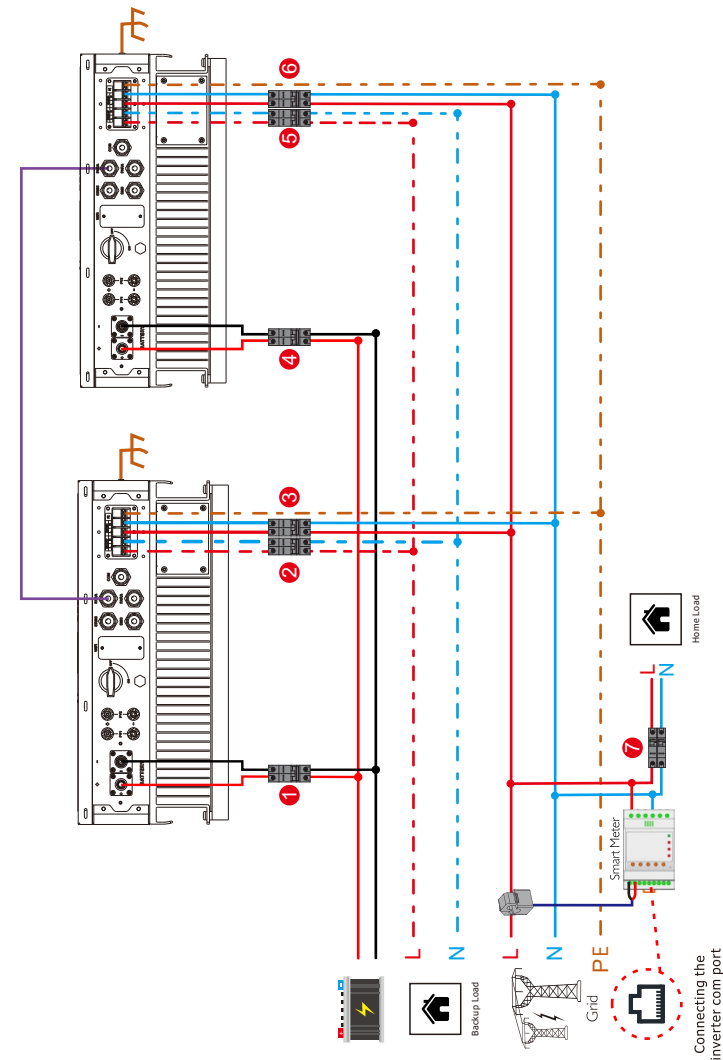

- (1) ①④ :150A DC Breaker for battery, ②⑤ :40AAC breaker, ③⑥ :63AAC breaker, ⑦ :AC breaker, size depends on home load.
- (2)The PARA ports of the first and last inverters are plugged into the Parallel connector.
- (3)The storage battery BMS communication cable can be connected to any machine that has been powered up in the parallel system, (refer to section 4.6 for BMS wiring).
- (4)Ensure that the meter and CT are connected between the house load and the grid and are installed according to the markings on the CT (arrows pointing to the grid side), see Figure 4.4-4 in Section 4.4.
- (5)The single-phase smart meter communication cable can be connected to the COM port of any inverter that has been powered up and switched on in the parallel system. (Refer to section 4.4 for meter communication wiring).
- (6)For PV module wiring, please refer to sections 4.1 and 4.8 for connection. Note that each group of PV panels is only allowed to be connected into one machine.

7.3.2 Parallel connection of three inverters

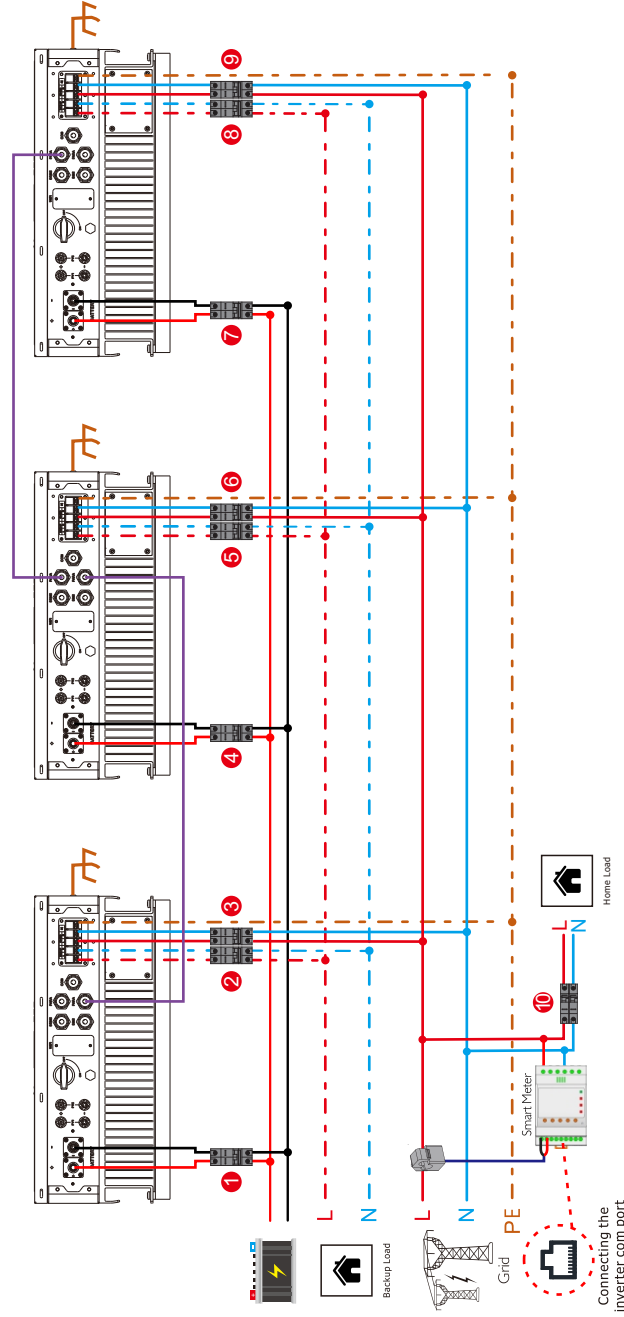

- (1) ①④⑦: 150A DC Breaker for battery, ②⑤⑧: 40A AC breaker, ③⑥⑨: 63A AC breaker, ⑩: AC breaker, size depends on home load.
- (2) The PARA ports of the first and last inverters are plugged into the Parallel connector.
- (3) The storage battery BMS communication cable can be connected to any machine that has been powered up in the parallel system, (refer to section 4.6 for BMS wiring).
- (4) Ensure that the meter and CT are connected between the house load and the grid and are installed according to the markings on the CT (arrows pointing to the grid side), see Figure 4.4-4 in Section 4.4.
- (5) The single-phase smart meter communication cable can be connected to the COM port of any inverter that has been powered up and switched on in the parallel system. (Refer to section 4.4 for meter communication wiring).
- (6) For PV module wiring, please refer to sections 4.1 and 4.8 for connection. Note that each group of PV panels is only allowed to be connected into one machine.

7.3.3 Parallel connection of multiple inverters

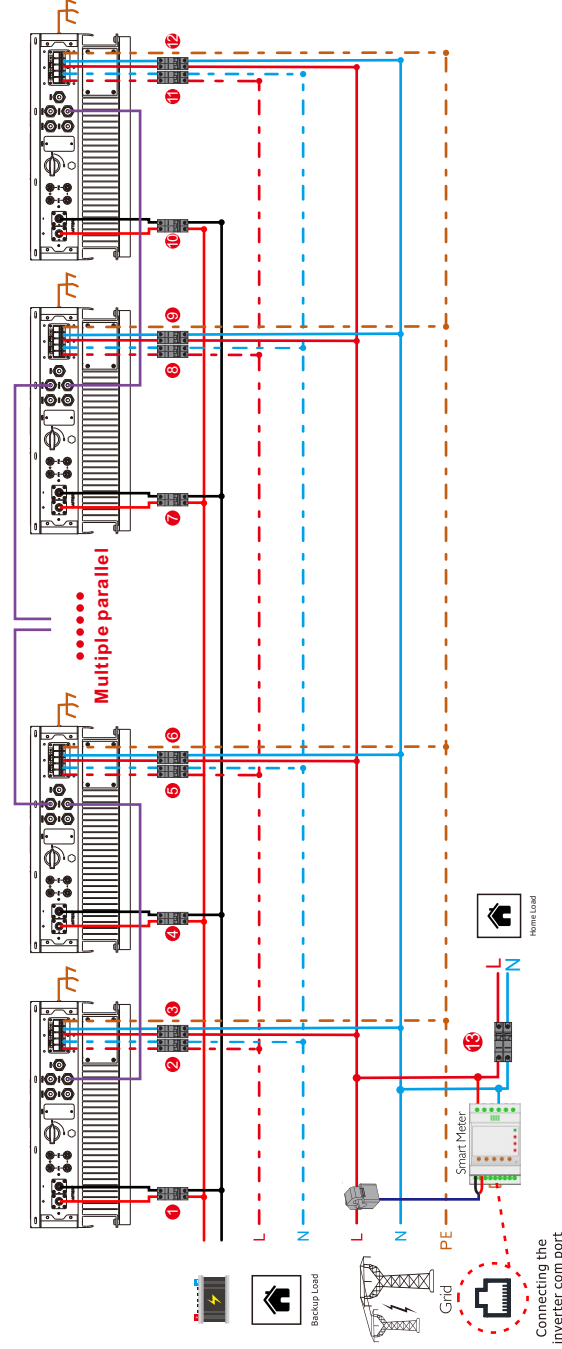

- (1) ①④⑦⑩: 150A DC Breaker for battery, ②⑤⑧⑪: 40A AC breaker, ③⑥⑨⑫: 63A AC breaker, ⑬: AC breaker, size depends on home load.
- (2) Multiple parallel machines need to connect the parallel inverters to the corresponding system bus in parallel with the CAN communication line and the input/output power line according to the single-phase parallel connection of two inverters.
- (3) The PARA ports of the first and last inverters are plugged into the Parallel connector.
- (4) The storage battery BMS communication cable can be connected to any machine that has been powered up in the parallel system, (refer to section 4.6 for BMS wiring).
- (5) Ensure that the meter and CT are connected between the house load and the grid and are installed according to the markings on the CT (arrows pointing to the grid side), see Figure 4.4-4 in Section 4.4.
- (6) The single-phase smart meter communication cable can be connected to the COM port of any inverter that has been powered up and switched on in the parallel system. (Refer to section 4.4 for meter communication wiring).
- (7) For PV module wiring, please refer to sections 4.1 and 4.8 for connection. Note that each group of PV panels is only allowed to be connected into one machine.

## 7.4 three-phase parallel connection

Note:

- (1) All input and output power lines of the inverter are connected to the bus through the circuit breaker and are connected in phase sequence.
- (2) Before the parallel system is powered up and started, please make sure that the battery negative poles of each inverter are connected together, and each inverter make sure that the parallel mode is set.
- (3) Do not connect power cables between inverters set to different phases as this may damage the inverter.
- (4) Do not connect the AC input neutral (N) to the AC output neutral (N).

### 7.4.1 Three-phase parallel system smart meter connection



Figure 7.4.1-1 Smart Meter

- (1) Signal and auxiliary power terminals: "5, 6, 7, 8, 9, 10" is the terminal number of the input current signal; "1, 2, 3, 4" is the terminal number of the input voltage signal; "12, 13" are auxiliary power terminal numbers.

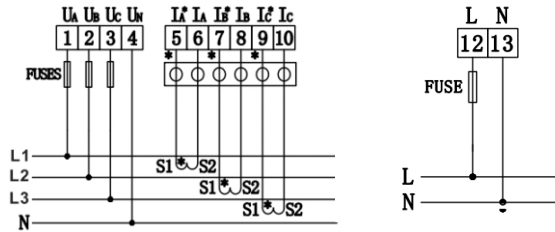

- (2) Smart meter RS485 communication port.

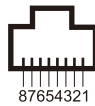

Figure 7.4.1-2 RS485 interface

Table:7.4.1-2:RS485 interface

NO.	8	7	6	5	4	3	2	1
Function	485A	485B	485A	GND1	GND1	485B	NC	NC

- (3) The three-phase smart meter is a necessary device for the installation of the T-REX three-phase parallel system, which is used to detect the direction and magnitude of the grid voltage and current, and to indicate the operation status of the T-REX inverter through RS485 communication.
- (4) The three-phase smart meter and inverter communication connection cables are the same as for single-phase smart meters, see Section 4.4.

### 7.4.2 Parallel connection of three inverters

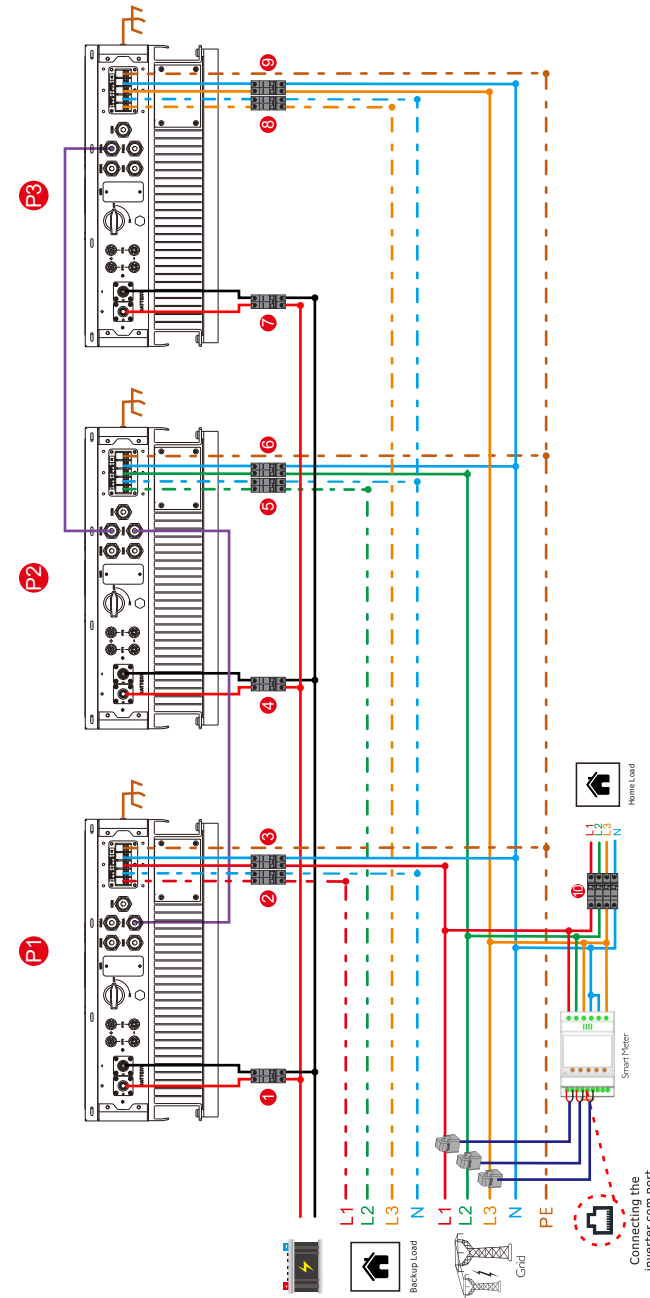

- (1) ①④⑦:150A DC Breaker for battery, ②⑤⑧:40A AC breaker, ③⑥⑨:63A AC breaker, ⑩:AC breaker, size depends on home load.
- (2) The PARA ports of the first and last inverters are plugged into the Parallel connector.
- (3) The storage battery BMS communication cable can be connected to any machine that has been powered up in the parallel system, (refer to section 4.6 for BMS wiring).
- (4) The single-phase smart meter communication cable can be connected to the COM port of any inverter that has been powered up and switched on in the parallel system. (Refer to section 4.4 for meter communication wiring).
- (5) For PV module wiring, please refer to sections 4.1 and 4.8 for connection. Note that each group of PV panels is only allowed to be connected into one machine.



7.4.3 Parallel connection of six inverters

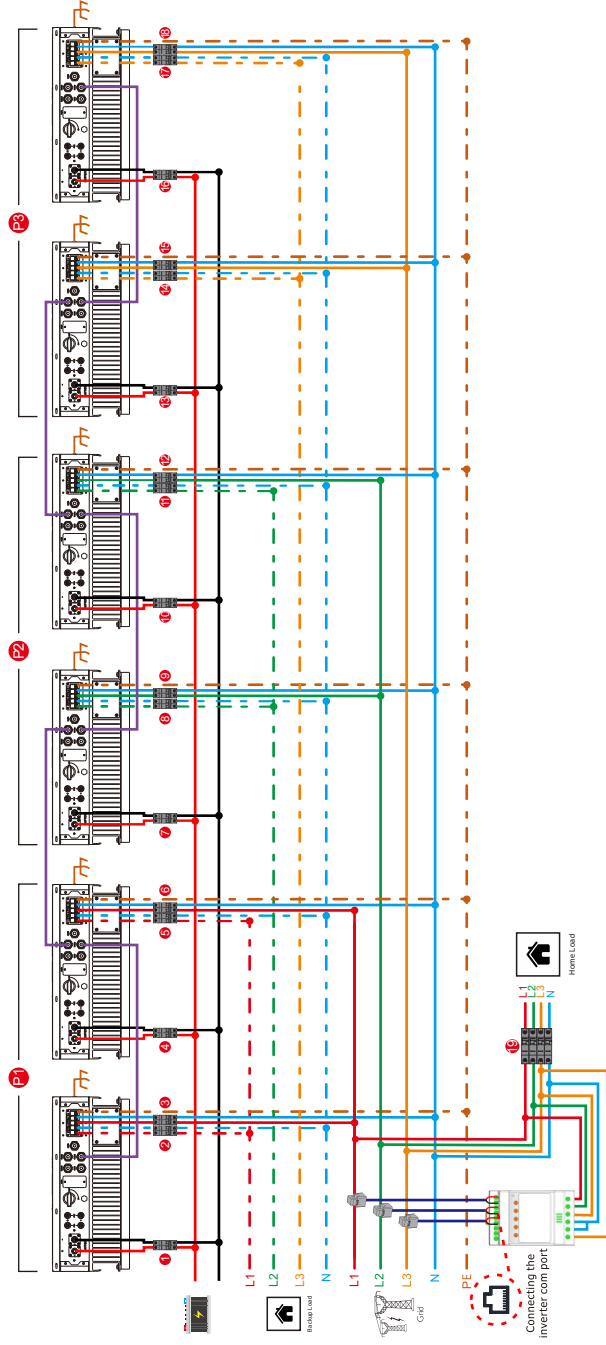

- (1) ①④⑦⑩⑬⑯: 150A DC Breaker for battery, ②⑤⑧⑪⑭⑰: 40A AC breaker, ③⑥⑨⑫⑮⑱: 63A AC breaker, ⑳: AC breaker, size depends on home load.
- (2) The PARA ports of the first and last inverters are plugged into the Parallel connector.
- (3) The storage battery BMS communication cable can be connected to any machine that has been powered up in the parallel system, (refer to section 4.6 for BMS wiring).
- (4) Ensure that the meter and CT are connected between the house load and the grid and are installed according to the markings on the CT (arrows pointing to the grid side), see Figure 4.4-4 in Section 4.4.
- (5) The single-phase smart meter communication cable can be connected to the COM port of any inverter that has been powered up and switched on in the parallel system. (Refer to section 4.4 for meter communication wiring).
- (6) For PV module wiring, please refer to sections 4.1 and 4.8 for connection. Note that each group of PV panels is only allowed to be connected into one machine.

7.4.4 Parallel connection of multiple inverters

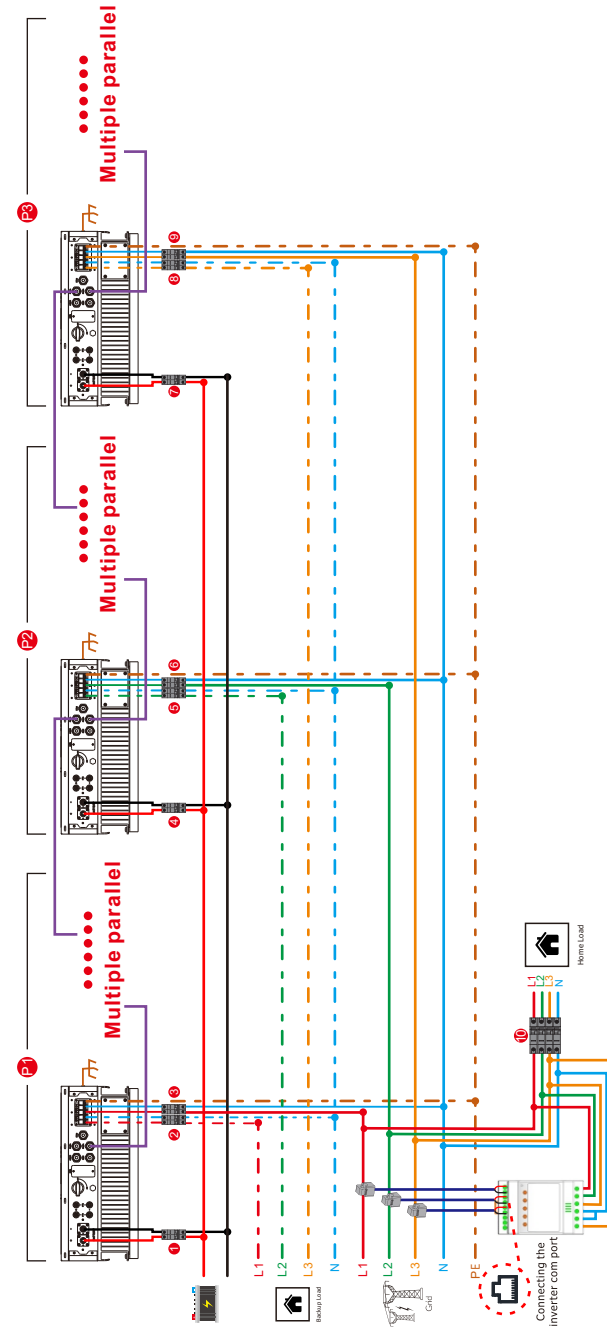

- (1) ①④⑦⑩⑬⑯: 150A DC Breaker for battery, ②⑤⑧⑪⑭⑰: 40A AC breaker, ③⑥⑨⑫⑮⑱: 63A AC breaker, ⑳: AC breaker, size depends on home load.
- (2) When paralleling multiple units per phase, it is necessary to connect the inverters connected in parallel to the system power line of the corresponding phase in the same way as two inverters are connected in single-phase parallel.
- (3) The PARA ports of the first and last inverters are plugged into the Parallel connector.
- (4) The storage battery BMS communication cable can be connected to any machine that has been powered up in the parallel system, (refer to section 4.6 for BMS wiring).
- (5) Ensure that the meter and CT are connected between the house load and the grid and are installed according to the markings on the CT (arrows pointing to the grid side), see Figure 4.4-4 in Section 4.4.
- (6) The single-phase smart meter communication cable can be connected to the COM port of any inverter that has been powered up and switched on in the parallel system. (Refer to section 4.4 for meter communication wiring).
- (7) For PV module wiring, please refer to sections 4.1 and 4.8 for connection. Note that each group of PV panels is only allowed to be connected into one machine.

## 7.5 LCD Manual Setting Parallel Mode

Note:

- (1) Single-phase systems and three-phase systems manually set parallel mode Sections 7.5.1, 7.5.2, 7.5.3, and 7.5.6 have the same process, Section 7.5.4 is the single-phase parallel setup process, and Section 7.5.5 is the three-phase parallel setup process.
- (2) Single-phase and three-phase parallel settings allow only one of the parallel modes to be set.

7.5.1 The machine should be set in standby when setting the parallel mode, otherwise the setting can not be done, The LCD displays the standby condition as shown in the figure below.

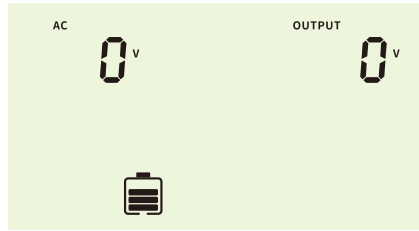

7.5.2 Simultaneously press and hold up and down keys until it enters the setting mode, The LCD display enters as shown below.

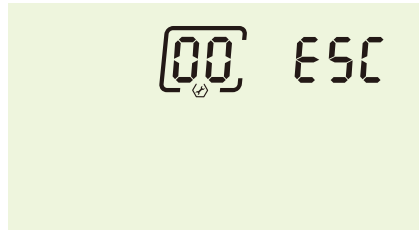

7.5.3 Press Up or Down key to switch the option until the interface is 28 option, then press Enter key to enter the parallel mode selection, The LCD display entry options and mode selections are shown below.

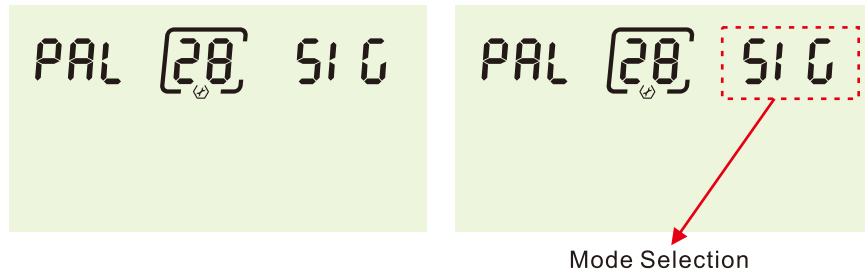

7.5.4 Parallel single-phase system: press up or down key to switch mode, parallel single-phase system mode select PAL, then press Enter key to set, The LCD displays the parallel single-phase system mode as shown below.

Note: Each machine of the system needs to be set consistently.

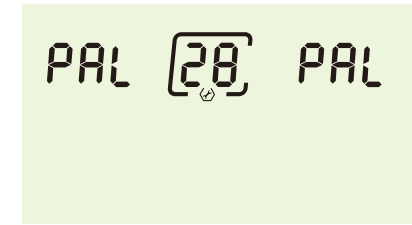

7.5.5 Parallel three-phase system: press the up or down key to switch the mode, parallel three-phase system of each phase line corresponding to the machine in the parallel mode selection to select L1 or L2 or L3, the three can not be duplicated settings, selection is complete press the Enter key to set up, The LCD displays the mode selection for each phase of a parallel three-phase system as shown below.

Note: The phase lines of the corresponding inverters should all be set to the same. After the stand-alone machine is successfully powered on to set the mode, a 25 warning will appear on the LCD screen, which is a normal phenomenon.

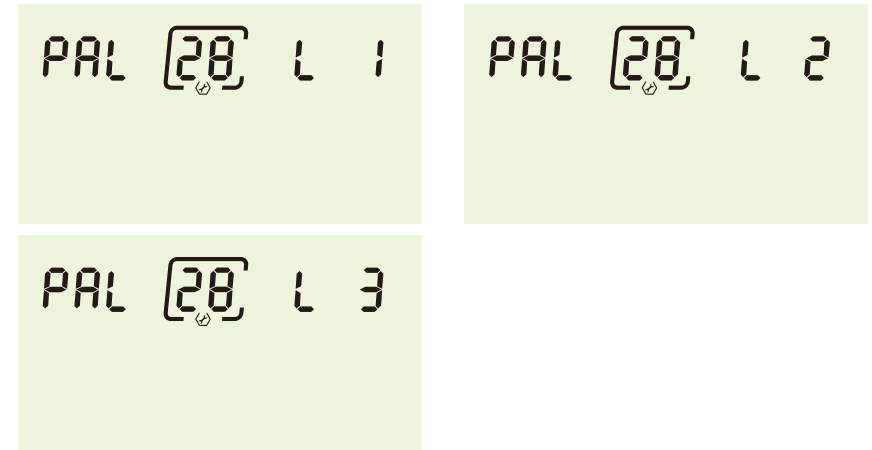

7.5.6 The above settings are completed, press the ESC key to exit, the machine enters the standby interface and then long Enter key to enter the inverter output state, the inverter can be powered off and shut down. And three-phase parallel system into the inverter output mode, a 25 warning will appear on the LCD screen, this phenomenon is normal, each inverter set up after the completion of the parallel mode need to ensure that the inverter into the inverter output mode, The LCD shows the inverter entering The LCD shows the inverter entering the inverter output mode as shown below.

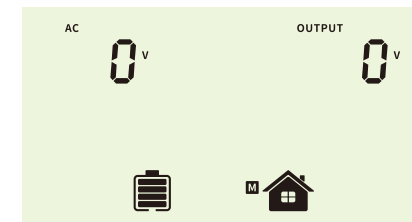

7.5.7 After all the above inverters have been set up, all inverters are powered on and running.



## 8.Warning Code Table

When fault event happens, the fault LED is flashing. At the same time, warning code, icon  is shown on the LCD screen.

Warning Code	Warning Information	Audible Alarm	Trouble Shooting
07	Low battery		The battery voltage is too low, it should be charging.
09	Overload	Beep twice every second	Reduce the loads.
25	Phase Sequence Errors		Check that the input and output power lines correspond
51	BMS doesn't allow inverter to discharge battery.		Inverter will stop discharging battery automatically.
52	BMS require inverter to charge battery.		Inverter will charge battery automatically.
60	BMS firmware version is not matched.		Upgrade the firmware of BMS.

## 9.Troubleshooting

This chapter describes the fault alarm and fault code for quick troubleshooting.

Table 7-1 Fault code

Fault Code	Fault information	Trouble Shooting
01	PV voltage is too high	Reduce the number of Pv modules in series.
02	Over current happen at PV port	Restart the unit, if the error happens again, please return to repair center.
04	Stort circuit happen at PV port	Check if wiring is connect well.
06	Pv current sensor failed	Restart the unit, if the error happens again, please return to repair center.
07	Battery voltage is too high	Check if spec and quantity of batteries are meet requirements.
10	Abnormal LLC	Restart the unit, if the error happens again, please return to repair center.
11	Over current happen at Buckboost	Restart the unit, if the error happens again, please return to repair center.
14	BuckBoost is out of balance	Restart the unit, if the error happens again, please return to repair center.
15	Buckboost current sensor failed	Restart the unit, if the error happens again, please return to repair center.
16	NO.2 Buckboost current sensor failed	Restart the unit, if the error happens again, please return to repair center.

17	Overload time out	Reduce the connected load by switching off some equipment.
19	Output short circuited	Check if wiring is connected well and remove abnormal load.
20	Input output reverse	Confirm that the input and output wiring is correct.
21	OP current sensor failed	Output current sensor failed
22	Output voltage is too low	Reduce the connected load.
23	Output voltage is too high	Restart the unit, if the error happens again, please return to repair center.
24	Over current or surge detected by Software	Restart the unit, if the error happens again, please return to repair center.
25	Hardware detect over current at inverter port	Restart the unit, if the error happens again, please return to repair center.
26	Invert soft start failed	Internal components failed. Restart the unit, if the error happens again, please return to repair center.
28	The DC component of the inverter current is abnormal	Restart the unit, if the error happens again, please return to repair center.
29	Inverter current sensor failed	Restart the unit, if the error happens again, please return to repair center.
30	Bus voltage is too low	Restart the unit, if the error happens again, please return to repair center.
31	Bus voltage is too high	AC Surge or internal components failed. Restart the unit, if the error happens again, please return to repair center.
33	Bus soft start failed	Internal components failed. Restart the unit, if the error happens again, please return to repair center.
34	Over temperature happen at heat sink	Check whether the ambient temperature is too high.
35	The inner temperature over	Check whether the ambient temperature is too high.
36	Internal fan locking fault	Restart the unit, if the error happens again, please return to repair center.
38	Leakage current fault	Restart the unit, if the error happens again, please return to repair center.
39	Leakage current sensor failed	Restart the unit, if the error happens again, please return to repair center.
40	Isolation resistance to ground of the PV string is too low	Restart the unit, if the error happens again, please return to repair center.
42	Relay check failure	Restart the unit, if the error happens again, please return to repair center.

43	Parallel CAN COMM abnormality	Test the parallel communication line, restart still have problems please contact the after-sales service.
44	Loss of parallel hosts	
45	Parallel Synchronisation Signal Abnormal	
46	Inconsistency in parallel versions	1. Update all inverter firmware to the same version. 2. Check the version of each inverter via the LCD settings to ensure that the CPU versions are the same. If it is not the same, please contact after-sales personnel to update the firmware. 3. After updating, if the problem still exists, please contact after-sales.
47	Inconsistent parallel settings	Single-phase parallel system and group three-phase system setup error
48	Failure of the parallel system as a whole	Specific faults in other machines in the parallel system
49	Parallel negative power protection	Restart the unit, if the error happens again, please return to repair center.
50	EEPROM failure	Restart the unit, if the error happens again, please return to repair center.
51	DSP1 communication failure	Restart the unit, if the error happens again, please return to repair center.
52	DSP2 communication failure	Restart the unit, if the error happens again, please return to repair center.
53	PV parallel failure	Please confirm whether PV1 and PV2 need to be set to parallel mode. If not, please turn off this function in APP. If necessary, please confirm whether the wiring of PV1 and PV2 is connected to parallel mode.
54	Temperature sensor disconnected	Restart the unit, if the error happens again, please return to repair center.
87	Battery input circuit failure	Restart the unit, if the error happens again, please return to repair center.

## Appendix

Model	T-REX-3KLP1G01	T-REX-3K6LP1G01	T-REX-4KLP1G01	T-REX-4K6LP1G01	T-REX-5KLP1G01	T-REX-6KLP1G01
<b>Battery Input Data</b>						
Battery Voltage Range	40V~60V					
Max. charging and discharging current	100A/100A					120A/120A
Max. charging and discharging power	3000W	3600W	4000W	4600W	5000W	6000W
Battery type	Li-Ion /Lead-acid					
<b>DC Input Data (PV side)</b>						
Max. recommended PV power	3900W	4700W	5200W	6000W	6500W	7800W
Max. PV voltage	550V					
Start voltage	130V					
PV voltage range	90V~550V					
MPPT voltage range	100V~500V					
MPPT Voltage Range for Full Load	140V~500V	160V~500V	175V~500V	200V~500V	220V~500V	260V~500V
Nominal voltage	360V					
Max. input current	15A/15A					
Max. shorted current	18A/18A					
Number of MPP trackers /strings per MPP tracker	2/1					
<b>Grid Data</b>						
Nominal Input Voltage	230Vac					
Input Voltage Range	184~264.5Vac					
Nominal grid frequency	50/60Hz					
Max. input current	40A					
Max. Charge Current	100A					120A
Max. AC output power	3000W	3600W	4000W	4600W	5000W	6000W
AC Output Rated Current	13A	15.6A	17.4A	20A	21.7A	26A
Max. output current	16.3A	19.5A	21.7A	25A	25A	30A
Max. Continuous AC Passthrough	30A					

Power factor	>0.99					
Displacement power factor	0.8leading...0.8lagging					
THDI	<3%					
<b>AC Output Data(Back Up)</b>						
Rated output power	3000VA/3000W	3600VA/3600W	4000VA/4000W	4600VA/4600W	5000VA/5000W	6000VA/6000W
Max. Output current	30A					
Rated AC output voltage	230Vac					
Rated AC output frequency	50/60Hz					
<b>AC Output Data(Back Up)</b>						
Max. efficiency	97.5%	97.5%	97.5%	97.6%	97.6%	97.6%
Euro efficiency	96.7%	96.7%	96.8%	97%	97%	97%
MPPT efficiency	99.9%					
<b>Protection</b>						
Output over current protection	Integrated					
Output over power protection	Integrated					
Output shorted protection	Integrated					
Anti-islanding protection	Integrated					
GFCI Protection	Integrated					
Insulation Resistor Detection	Integrated					
<b>General Data</b>						
Operating temperature range	-25°C~60°C, >45°C Derating					
Protection degree	IP65					
Relative humidity	100%					
Cooling concept	Nature					Intelligent Air Cooling
Altitude	2000m					
Communication	RS232/RS485					
BMS Communication	CAN/RS485					
Monitor module	WiFi/GPRS					

Display	LCD+LED
Installation Style	Wall-mounted
Warranty	10 years
Grid Regulation	VDE-AR-N 4105; G99/1; EN50549-1; CEI 0-21; AS 4777.2; NRS 097-2-1;
Safety Regulation	IEC 62109-1/2 , IEC 62040-1
EMC	EN61000-6-1 , EN61000-6-3
Net Weight	32.4KG
Gross Weight	39.1KG
Product Dimension	530*493*228MM
Package Dimension	632*570*315MM
[1]Conditions apply, refer to FelicityESS Warranty policy.	

**\* According to local grid-connected standards**

**Features:**

- Support WiFi for mobile monitoring
- 48V low voltage battery, transformer isolation topology
- Max. charging/discharging current of 120A
- AC couple to retrofit existing solar system
- Support storing energy from diesel generator
- Power supply can be switched automatically and switching time within 20ms