



User Manual



LiFePO4 Battery System

Contents

1. INTRODUCTION	1
2. SYMBOLS	1
3 Safety	2
3.1 Safety Rules.....	2
3.2 Safety Information.....	2
3.3 Installation.....	3
4. RESPONSE TO EMERGENCY SITUATIONS	3
4.1 Fire Situation.....	3
5. TRANSPORTATION	3
5.1 Regulations for the transport of battery modules.....	3
5.2 Permissible andImpermissible Storage Positions of a Packaged.....	4
6. STORAGE	5
7. PRODUCT INFORMATION	5
7.1 Battery Module Specifications.....	5
8. ELECTRICAL CONNECTIONS	7
8.1 Battery System Features.....	7
8.2 Battery system introduction.....	7
8.3 Electrical Interface Description of Control cabinet.....	8
8.4 Battery box introduction.....	8
8.5 Base introduction.....	9
8.6 Switch On / Off.....	9
9. INSTALLATION	9
9.1 Items in the package.....	9
9.2 Product size information.....	11
9.3 Tools.....	12
9.4 Floor installation with base.....	12
9.5 Installation Procedure.....	13
9.6 Install Environment.....	14
9.7 System Wiring Schematic.....	15
9.8 Ground connection.....	15
9.9 Power line connection.....	16
9.10 Terminal Connection.....	16
9.11 Description for Communication port.....	17
9.12 Install protective cover.....	17
10. LCD Displayicons	18
10.1 Main Interface.....	18
10.2 Fault Code Table.....	20
11. WARRANTY	21
12. TROUBLESHOOTING AND MAINTENANCE	21
12.1 Maintenance.....	21
12.2Troubleshooting.....	21











1. INTRODUCTION

The document describes the installation, commissioning, maintenance and troubleshooting of the following high voltage battery listed below.

The battery chemistry of these products is Lithium Iron Phosphate. This manual is designed for qualified personnel only. The tasks described in this document should be performed by authorized and qualified technicians only.

After Installation the Installer must explain the user manual to the end user.

2. SYMBOLS

	Caution, risk of electric shock.
	Do not place nor install near flammable or explosive materials.
	Install the product out of reach of children.
	Read the instruction manual before starting installation and operation.
	Do not dispose of the product with household wastes.
	Recyclable.
	Disconnect the equipment before carrying out maintenance or repair.
	Observe precautions for handling electrostatic discharge sensitive devices.
	Protective Class 1.
	Caution, risk of electric shock, energy storage timed discharge.

SPECIFICATIONS FOR LUX-Y-48100HG01

The battery system is mainly used insolar power system for family houselt also has a switch to control the battery easilyand timely protect our Household application

3. SAFETY

3.1 Safety rules

To avoid property damage and personal injury, the following rules shall be flowled when working on the hazardous live parts of the battery energy storage system:

- It is available for use.
- Ensure that it will not restart.
- Make sure there is no voltage.
- Grounding protection and short circuit protection.
- Cover or shield adjacent live parts.

3.2 Safety information

Part damage or short circuit may cause electric shock and death. A short circuit can be caused by connecting battery terminals, resulting in current flow, This type of short circuit shall be avoided under any circumstances, For this reason, follow these instructions:

- Use insulated tools and gloves.
- Do not place any tools or metal parts on the battery module or high-voltage control box.
- When operating the battery, be sure to remove watches, rings, and other metal objects.
- Do not install or operate this system in explosive or high-humidity areas.
- When working on the energy storage system, first turn off the charging controller, then the battery, and ensure that they are not turned on again.

Improper use of the battery energy storage system can lead to death. The use of the battery energy storage system beyond its intended use is not allowed, because it may cause great danger.

Improper handling of the battery energy storage system can cause life-threatening risks, serious injury or even death.



Warning! improper use can cause damage to the battery cell.

- Do not expose the battery module to rain or soak it in liquid.
- Do not expose the battery module to a corrosive environment (such as ammonia and salt).
- The battery energy storage system shall be debugged no later than six months after delivery.

3.3 Installation

- After unpacking, please check the product for damages and missing parts.
- Make sure that the inverter and battery is completely turned off before commencing installation.
- Do not interchange the positive and negative terminals of the battery.
- Ensure that there is no short circuit of the terminals or with any external device.
- Do not exceed the battery voltage rating of the inverter.
- Do not connect the battery to any incompatible inverter.
- Do not connect different battery types together.
- Please ensure that all the batteries are grounded properly.
- Do not open the battery to repair or disassemble.
- In case of fire, use only dry powder fire extinguisher.
- Install the battery away from children or pets.
- Do not use battery in high static environment where the protection device might be damaged.
- Do not install with other batteries or cells.

4. RESPONSE TO EMERGENCY SITUATIONS

The batteries comprise of multiple batteries connected in series. It is designed to prevent hazards or failures. However, FelicityESS cannot guarantee their absolute safety. Under exposure to the internal materials of the battery the following recommendations should be carried out by the user.

- If there has been inhalation, please leave the contaminated area immediately and seek medical attention.
- If there has been contact with eyes, rinse the eyes with running water for 15 minutes and seek medical attention immediately.
- If there has been contact with the skin, wash the contacted area with soap thoroughly and seek medical attention immediately.
- If there has been ingestion, induce vomiting and seek medical attention.

4.1 Fire Situation

Use a FM-200 or Carbon Dioxide (CO2) fire extinguishers to extinguish the fire if there is a fire in the area where the battery pack is installed. Wear a gas mask and avoid inhaling toxic gases and harmful substances produced by the fire.

5. TRANSPORTATION

5.1 Regulations for the transport of battery modules

It is necessary to comply with the relevant regulations and provisions on roads for shipping lithium-ion products in the corresponding countries.



- Smoking is prohibited in the vehicle during transportation or in the vicinity during loading and unloading



- The dangerous goods transport vehicles shall meet relevant regulations concerning road transportation and shall be equipped with two tested CO2 fire extinguishers.



- It is forbidden for the freight forwarder to open the outer package of the battery module. Use only approved lifting equipment to move the battery cabinet system. Use only the hanging lug on the top of the battery cabinet as the connection point. When lifting, the angle of the sling must be at least 60°.



- The battery energy storage system can be damaged, if not properly transported. The battery module can only be transported vertically. Note that these parts may be top-heavy. Failure to follow this instruction may result in damage to the part.



- If possible, do not remove the transport packaging before arrival at the installation site. Before removing the transport protector, check if the transport packaging is damaged, and check the impact indicator on the outer packaging of the battery converter. If the impact indicator is triggered, the possibility of transport damage cannot be ruled out.



- Improper transport of battery modules may cause injury. The single battery module weighs 45kg. It could cause injury if it falls or slips. Use only suitable transport and lifting equipment to ensure safe transport.



- Wear safety shoes to avoid the danger of injury. When transporting the battery rack and battery module, their parts may be crushed due to their heavy weight. Therefore, all persons involved in transportation must wear safety shoes with toe caps. Please observe the safety regulations for transportation at the end customer's site, especially during loading and unloading.



- During transportation and installation of unpacked battery storage cabinets, the risk of injury increases, especially on sharp metal panels. Therefore, all personnel involved in transportation and installation must wear protective gloves.



- Improper vehicle transportation can cause injury. Improper transportation or improper transportation locks may cause the load to slip or overturn, resulting in injury. The cabinet shall be placed vertically to prevent it from sliding in the vehicle, and a fixing belt shall be used.

5.2 Permissible and Impermissible Storage Positions of a Packaged

The battery module can only be transported in an upright position.

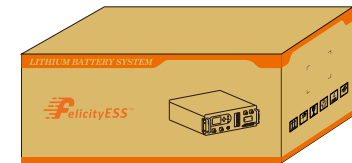
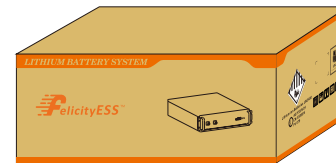

6. STORAGE

- Do not expose battery to open flame.
- Do not place the product under direct sunlight.
- Do not place the product near flammable materials. It may lead to fire or explosion in case of accident.
- Store in a cool and dry place with ample ventilation.
- Store the product on a flat surface.
- Store the product out of reach of children and animals.
- Do not damage the unit by dropping, deforming, impacting, cutting or penetrating with a sharp object. It may cause leakage of electrolyte or fire.
- Do not touch any liquid spilled from the product. There is a risk of electric shock or damage to skin.
- Always handle the battery wearing the insulated gloves.
- Do not step on the product or place any foreign objects on it. This can result in damage.
- Do not charge or discharge damaged battery.

7. PRODUCT INFORMATION

1. LUX-Y-48100HMG01 is a battery module, it needs to be used with LUX-Y-48100HCG01 controller;
2. LUX-Y-48100HCG01 is the controller of the whole system, so each system must have four LUX-Y-48100HMG01;
3. Our system consists of at least 1 LUX-Y-48100HCG01 + 4 LUX-Y-48100HMG01 and up to 12 LUX-Y-48100HMG01.

7.1 Battery Module Specifications

Model	LUX-Y-48100HMG01		
Battery Type	LiFePO4		
Nominal Energy	5.12kWh		
Nominal Voltage	51.2V		
Nominal Capacity	100Ah		
Number of Battery Modules	4 (Min)	8	12
System Nominal Energy	20.48kWh	40.96kWh	61.44kWh
System Nominal Voltage	204.8V	409.6V	614.4V
System Operating Voltage	192-230.4V	384-460.8V	576-691.2V
Recommend Charge/Discharge current	50		
Max. continuous charge/Discharge current[1]	100A		
Peak Charge/Discharge current(15S)	120A		
Depth of discharge(DOD)	≥95%		
Display type	LED+LCD(Touch)		
IP Rating of Enclosure	IP21		
Working Temperature Range	Charge:0°C~+55°C		
	Discharge:-20°C~+55°C		

Storage Temperature Range		0°C~+35°C
Humidity		5%~95%
Altitude		≤2000m
Cycle Life[2]		≥ 6000 Cycles
Installation		Rack-Mounting
Protection		Built-in smart BMS, Breaker, Fuse
Communication Port		RS485 / CAN
Warranty Period[3]		10 Year
Control Module LUX-Y-48100HCG01	Product Dimension	482.6x565x150mm
	Package Dimension	687x562x269mm
	Product Weight Approximate	10.3kg
	Package Weight Approximate	16.7kg
Battery Module LUX-Y-48100HMG01	Product Dimension	482.6x565x131mm
	Package Dimension	687x562x250mm
	Product Weight Approximate	41.3kg
	Package Weight Approximate	45kg
Rack LUX-Y-48100HR13G01	Product Dimension	560×590×2077.5mm (13th floor)
	Package Dimension	678×708×2200mm
	Product Weight Approximate	68.5kg
	Package Weight Approximate	108.5kg
Rack LUX-Y-48100HR9G01	Product Dimension	560×590×1532.5mm (9th floor)
	Package Dimension	678×708×1655mm
	Product Weight Approximate	51kg
	Package Weight Approximate	80.5kg(Approx)
[1] Max. continuous charge/discharge current is affected by temperature and SOC.		
[2] Test conditions: 0.2C Charging/Discharging @25°C, 80% DOD.		
[3] Conditions apply, refer to FelicityESS Warranty policy.		

Charging method:

When the battery and inverter establish communication, the constant current of 100A is charged until the battery voltage reaches $54.4V * N$, and then the current decreases linearly until the voltage reaches $56.8V * N$ and the current drops to 0A (N is the number of battery packs in series)

8. ELECTRICAL CONNECTIONS

8.1 Battery System Features

The batteries have been fitted with multiple protection systems to ensure the safe operation of the system. Some of the protection system includes:

- Inverter interface protection: Over voltage, Over current, External Short Circuit, Reverse Polarity Ground Fault, Over Temp, In rush current.
- Battery Protection: Internal Short Circuit, Over voltage, over current, over temp, Under voltage The battery system contains the following Interface to allow it to connect and operate efficiently.
- LiFePO4: Higher safe performance and longer cycle life.
- Flexible Installation: Rack-Mounting.
- Wide Compatibility: Compatible with leading inverter brands.
- Long Warranty: 10 Years.

8.2 Battery system introduction

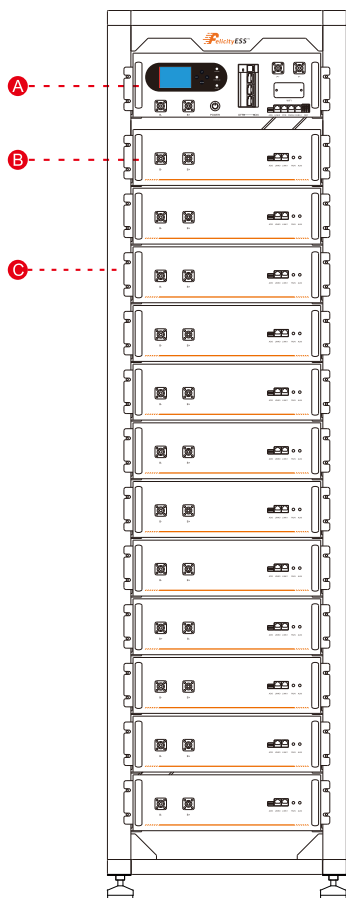

Code	Name	Product Model
A	Control cabinet	LUX-Y-48100HCG01
B	Battery box	LUX-Y-48100HMG01
C	Rack	*LUX-Y-48100HR13G01 *LUX-Y-48100HR9G01

* LUX-Y-48100HR13G01:
Built in 1 control module and UP to 12 battery modules

* LUX-Y-48100HR9G01:
Built in 1 control module and UP to 8 battery modules

8.3 Electrical Interface Description of Control cabinet

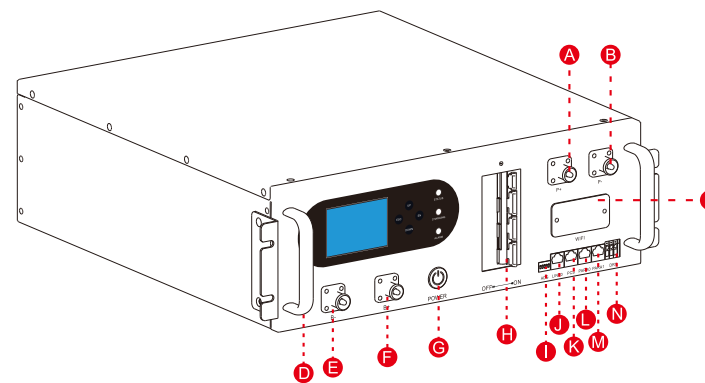

Code	Name	Code	Name
A	PCS +	H	Breaker
B	PCS -	I	ADS
C	WiFi Communication	J	LINK0
D	Handle	K	PCS Communication
E	BAT-	L	Parallel Interface 0
F	BAT+	M	Parallel Interface 1
G	Power Switch	N	Dry node

8.4 Battery box introduction

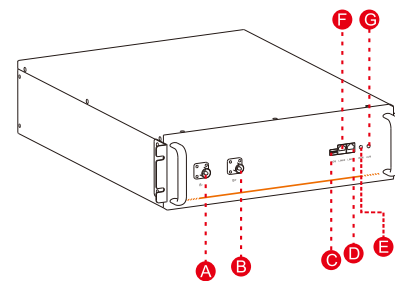

Code	Name
A	BAT-
B	BAT+
C	ADS
D	LINK1
E	Status LED
F	LINK0
G	Alarm LED

8.5 Base introduction

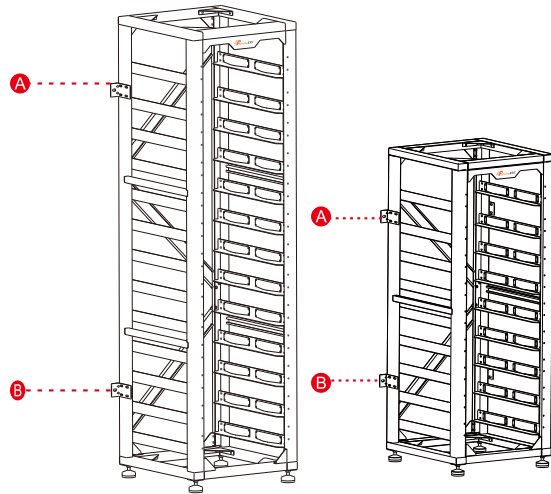

Code	Name
A	Rack
B	Fixed trestle

8.6 Switch On/Off

Switch on: close the breaker to the ON block, press and hold Power switch for 2-3 seconds, the battery will perform self-test before output. The LCD will show SOC.
 Switch off: close the breaker to the OFF block, the battery will shut down directly.

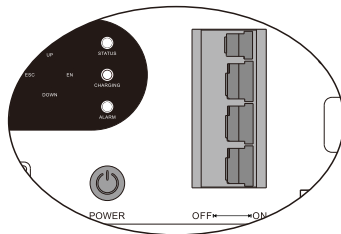

Power ON battery system







9. INSTALLATION

9.1 Items in the package

Packaging information

- The battery system consists of a battery, a control box, and a rack.
- Before unpacking the battery system, check whether the packaging is damaged and check the battery system model. If anything goes wrong, Do not open the packing case, and contact the after-sales service center as soon as possible.
- After unpacking the battery system, check the completeness of the product delivery against the packaging information. If there is any anomaly, please contact the after-sales service center as soon as possible.

LUX-Y-48100HCG01			
NO.	DESCRIPTION	QUANTITY	PICTURE
1	High-voltage control box 720V/100A	1	
2	User manual for LUX-Y-48100HG01	1	
3	Warranty card	1	
4	25mm positive power cord of the high-voltage control box (red)	1	
5	2m negative power cord of the high-voltage control box (black)	1	
6	5m positive power cord to connect External PCS (red)	1	
7	5m negative power cord to connect External PCS (black)	1	
8	Connected to external inverter communication cable	3	
9	M5*12 outer hexagon cross combination screw	4	
LUX-Y-48100HMG01			
NO.	DESCRIPTION	QUANTITY	PICTURE
1	5.12kWh battery module	1	
2	User manual for LUX-Y-48100HG01	1	
3	Warranty card	1	
4	60mm Power cord of battery module (red)	1	
5	Used for communication among batteries	1	

6	Used for grounding connections between battery modules	1	
7	M5*12 outer hexagon cross combination screw	4	
LUX-Y-48100HR13G01/LUX-Y-48100HR9G01			
NO.	DESCRIPTION	QUANTITY	PICTURE
1	Rack R13/R9	1	
2	Used to secure the rack	4	
3	M8*60 Expansion screw	4	
4	M5*12 outer hexagon cross combination screw	8	

9.2 Product size information

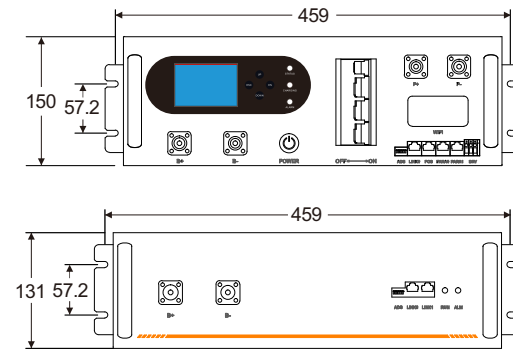
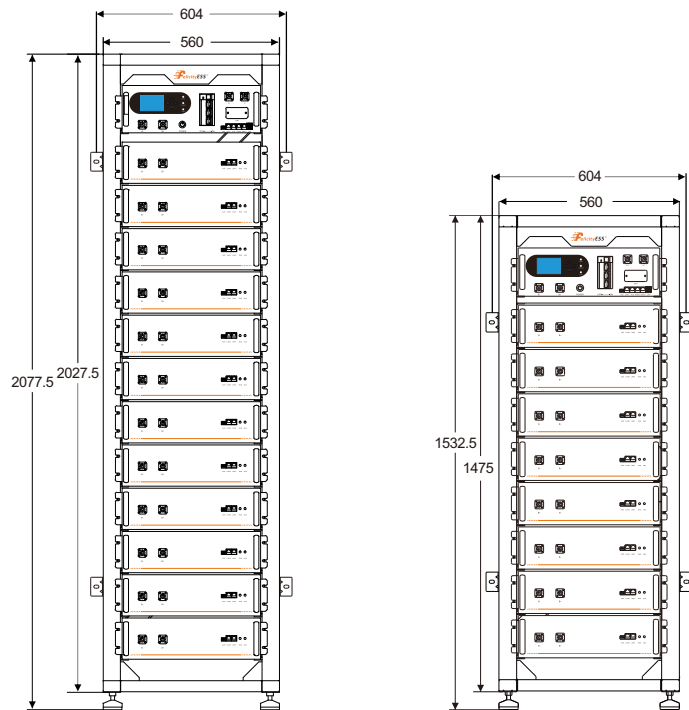

9.3 Tools

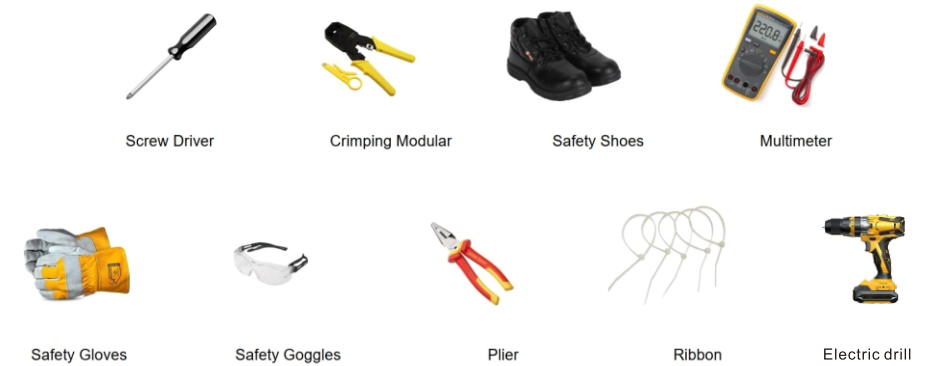

9.4 Floor installation with base

Installation Location Requirements

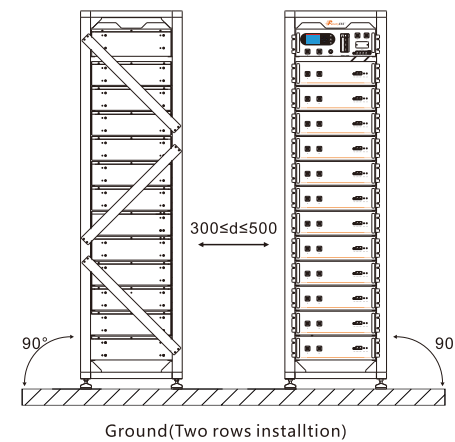

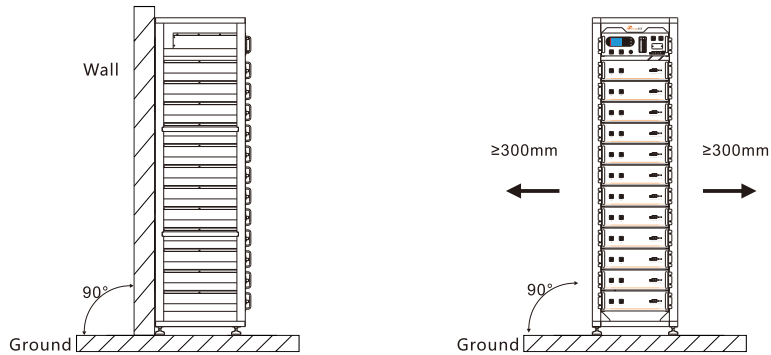

9.5 Installation Procedure

Step 1: Remove the battery, control box, and frame from the packing case.

Remove the support for fixing the rack package and fix it on the rack.

Step 2: Use a hammer drill to make a frame fixing hole in the wall. (Aperture 10mm, depth 60mm).

Step 3: Attach the rack to the wall, then install the battery from the bottom to the top, and make sure the battery is secured.

Step 1:

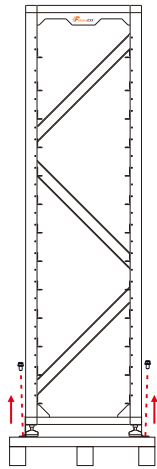

Step 2:

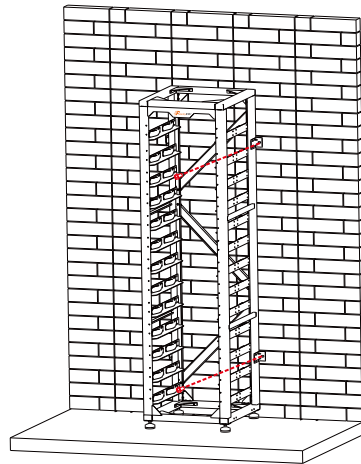

Step 3:

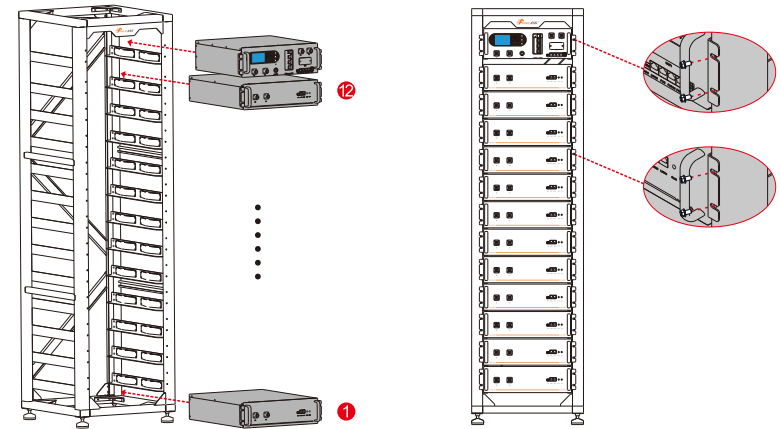

Note:

1. Before installation, check that the ground is flat and has no tilt.
2. Ensure that the rack is against a wall and secured.
3. When placed, it should be pushed inward from the bottom up and from the direction of the arrow.
4. When placing the battery, ensure that the battery is pushed to the bottom.
5. Fasten the battery with the accessory screws. Be careful that the battery falls down.
6. After securing the battery, insert the power cable.

9.6 Install Environment

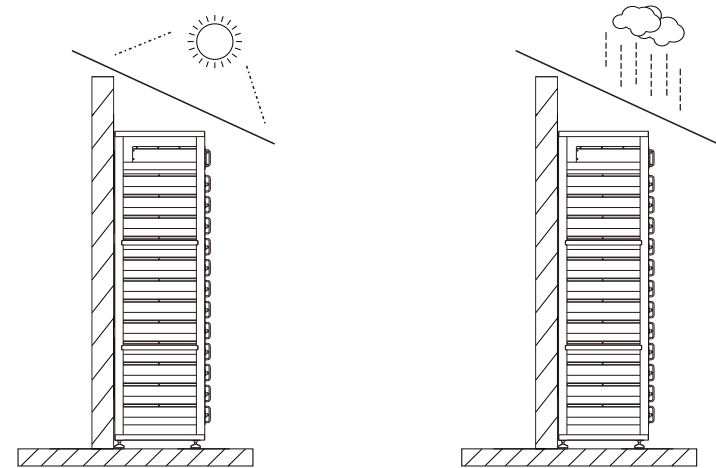

Max.+50°C



Min.-10°C



RH.+5%~+95%

9.7 System Wiring Schematic

Matching side inverter T-REX-50KHP3G01

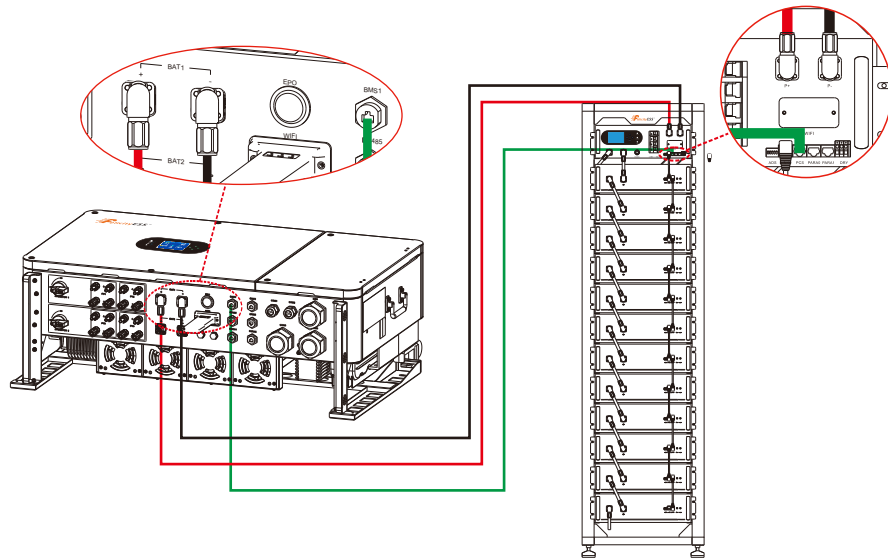

9.8 Ground connection

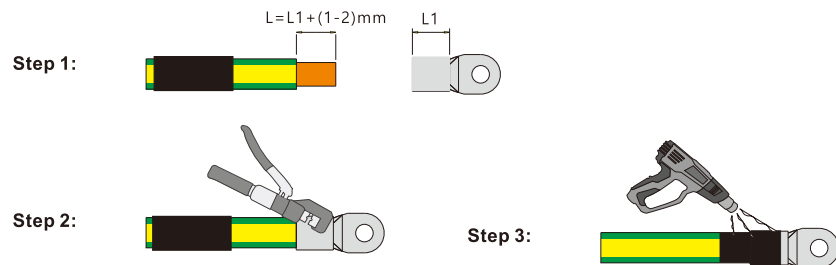

- Note:
- When installing equipment, the protective ground wire must be installed first;
 - When removing the equipment, the protective ground wire must be removed finally.
 - The drawing force after crimping shall be greater than 400N.
 - The control box is connected to the ground wire of the base.

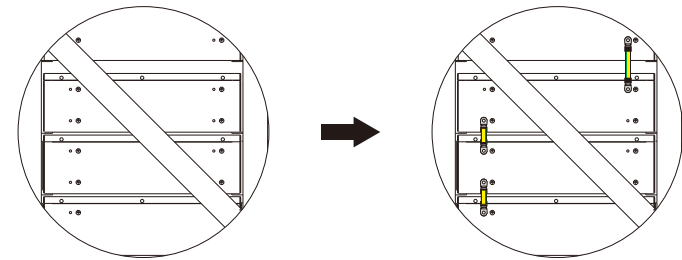

Note: Press the position indicated in the figure above before disconnecting the power terminal.

9.9 Power line connection

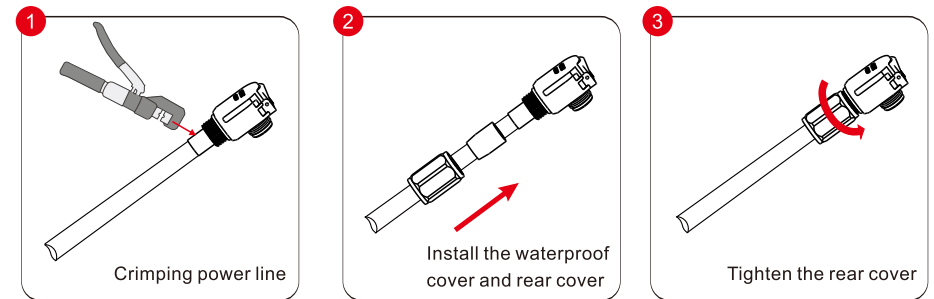

9.10 Terminal Connection

Power terminal

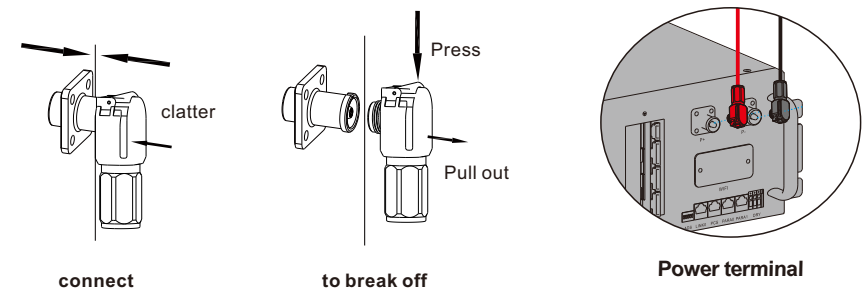

Note: Press the position indicated in the figure above before disconnecting the power terminal.

9.11 Description for Communication port

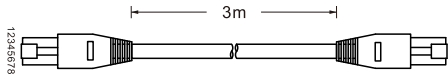

PCS Port

Pin	Function Definitions	Function Declaration
1	NC	NC
2	NC	NC
3	NC	NC
4	CAN-H	CAN-H
5	CAN-L	CAN-L
6	CAN-GND	CAN-GND
7	RS485-A	RS485-A
8	RS485-B	RA485-B

9.12 Install protective cover

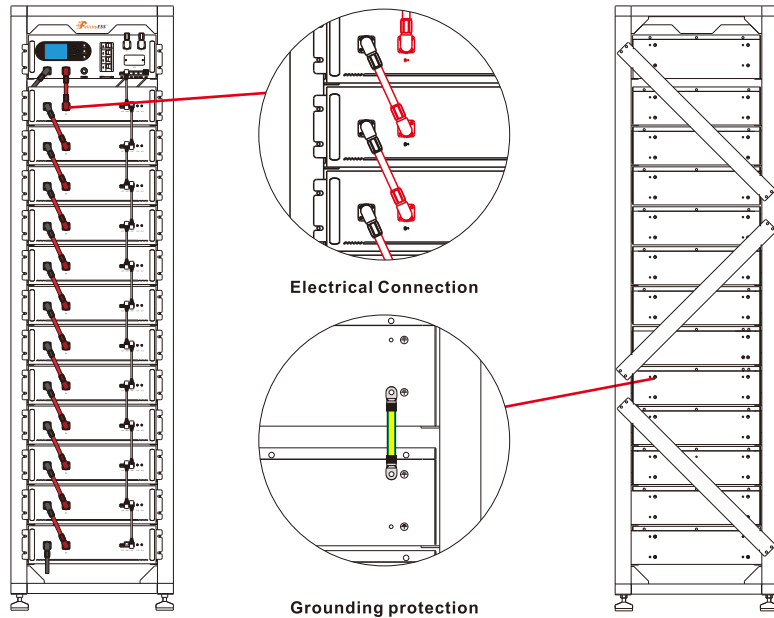



10. LCD Display icons



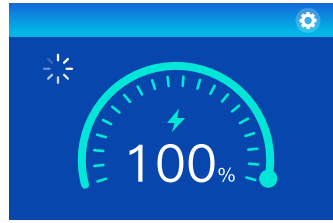

OBJECT	NAME	DESCRIPTION
A	LCD touch screen	Display the information of the battery.
B	Status LED	Indicates the operating status of the battery, which is always on when running normally.
C	Charging LED	Indicates the charging status of the battery, flashing indicates charging.
D	Alarm LED	Indicates the fault status of the battery, which lights up when the fault occurs.
ESC	Function Button	Esc: Return from current interface or function.
UP		Up: Move cursor to upside or increase value.
DOWN		Down: Move cursor to downside or decrease value.
EN		Enter: Confirm the selection.

10.1 Main interface



Battery Information	
	Indicate SOC.
	I Indicates the battery level, with each grid representing 5%.

	When charging, this icon lights up
	This icon lights up to indicate that the battery is waiting to be connected, and there is no output at this time. After entering normal working mode, this icon disappears.

Sum data interface:

This interface displays a summary of battery parallel connection information, including average battery voltage, total battery current, average BMS temperature, number of parallel connections, charging limit voltage, discharging limit voltage, charging limit current, discharging limit current, and fault information. Click "Sum Data" and "Details Data" to switch between summary data or detailed data of parallel batteries

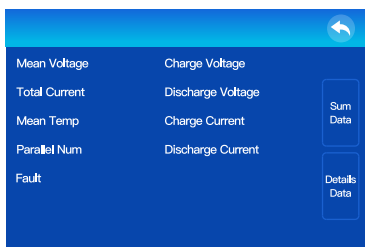

Details data interface:

This interface displays a summary of battery parallel connection information, including average battery voltage, total battery current, average BMS temperature, number of parallel connections, charging limit voltage, discharging limit voltage, charging limit current, discharging limit current, and fault information. Click "Sum Data" and "Details Data" to switch between summary data or detailed data of parallel batteries

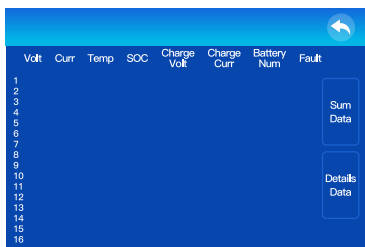

Details data interface:

This interface displays detailed information about parallel batteries, including minimum cell voltage, minimum cell voltage number, maximum cell voltage, maximum cell voltage number, minimum cell temperature, minimum cell temperature number, maximum cell temperature, and maximum cell temperature number

1 to 16 represent the addresses of parallel batteries.

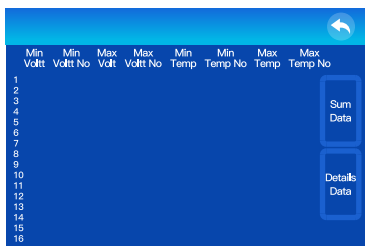

10.2 Fault Code Table

FAULT CODE	EXPLAIN	TREATMENT MEASURE
01	High Battery Voltage	Stop charging
02	Low Battery Voltage	Stop discharging
03	High Cell Voltage	Stop charging
04	Low Cell Voltage	Stop discharging
05	High Charging Current	Reduce charging current
06	High Discharging Current	Reduce discharging current
07	High Bms Temperature	Stop charging and discharging ,wait for the temperature to drop
08	Low Bms Temperature	Wait for temperature rise
09	High Cell Temperature	Stop charging and discharging , wait for the temperature to drop
10	Low Cell Temperature	Wait for temperature rise
11	Afe fault	Restart, if the fault still exists, contact our engineer
12	Soft Start Failed	Restart, if the fault still exists, contact our engineer
13	Slave Communication Failure	Check for poor contact of the communication line
14	Low Output Impedance	Restart, if the fault still exists, contact our engineer
15	Slave Version Fault	Contact our engineer to upgrade the progra
16	Slave Device Version Fault	Contact our engineer to upgrade the program
17	Parallel Fault	1. Please check if the number of parallel battery slave controls is the same 2. Please check if a single unit is installed in a parallel system 3.If this error occurs during parallel installation, please check the wiring. f they are connected correctly, please install them in parallel first and then restart the device. 4.If the problem persists, please contact the installation personnel.
18	Relay Adhesion Fault	Restart, if the fault still exists, contact our engineer

11. WARRANTY

The warranty shall not cover the defects caused by normal wear and tear, inadequate maintenance, handling, storage faulty repair, modifications to the battery or pack by a third party other than FelicityESS, failure to observe the product specification provided herein or improper use or installation, including but not limited to the following.

- Damage during transport or storage.
- Incorrect Installation of battery into pack or maintenance.
- Use of battery or pack in inappropriate environment.
- Improper, inadequate, or incorrect charge, discharge or production circuit other than stipulated herein.
- Incorrect use or inappropriate use.
- Insufficient ventilation.
- Ignoring applicable safety warnings and instructions.
- Altering or attempted repairs by unauthorized personnel.
- In case of force majeure (ex: lightning, storm, flood, fire, earthquake, etc.).
- There are no warranties-implied or express-other than those stipulated herein. FelicityESS shall not be liable for any consequential or indirect damages arising or in connection with the product specification, battery or pack.

12. TROUBLESHOOTING AND MAINTENANCE

12.1 Maintenance

1. Regularly check whether the service environment of the battery meets the requirements, and the installation position should be far away from the heat source.
2. In case of one of the following situations, it needs to be charged in time:
 - The battery is often under charged;
 - The battery has been out of use or stored for more than 3 months.
3. Regularly check whether the battery and its supporting terminals, connecting cables and indicator lights are normal.

12.2 Troubleshooting

When the red / white LCD on the panel is flashing or normally on, it does not mean that the Battery system is abnormal, it may be just an alarm or protection. Please check the 'Fault Code Table' in chapter 8 for the detailed faulty definition before any trouble-shooting steps. In general, the alarm indication is normal without manual intervention. When the alarm triggering state is removed, Battery system will automatically return to normal use.

- Problem determination based on the following points

- Whether the red light on the LUX-Y-48100HG01 is on;
- Whether the battery can be output voltage or not.
- Whether the battery system can be communicated with inverter;

- Preliminary determination steps

LiFePO4 Battery System for Households Battery system cannot work, when DC switch on and POWER on, the LCD doesn't light up or flash, please consider contact the local distributor.

- The LCD display of LUX-Y-48100HG01 is normal, but it cannot charge and discharge. Observe the display screen of inverter and there is no SOC. Please check whether the CAN communication between LUX-Y-48100HG01 to inverter is well connected. If the connection is good, please replace a CAN communication cable. If the SOC is still not visible on the inverter display screen, please contact the local distributor.
- After the battery system is powered on, if you can see the alarm information on the LCD and inverter display screen at the same time, please contact the local distributor.